



City of Merced Statement of Services

Dept. Head Sig.:	_____
Due Date:	7/24/2023
Return to:	Engineering Dept.
	678 W. 18th Street
	Merced, CA 95340

Vannesa Mendoza
Name of City Contact

(209) 385-6820
Phone Ext.

Description of Services to be Provided:*Official Use Only*

Saw cut and removal of damaged concrete and installation of railing along east side damaged railing on G st bridge.

Dokken engineering has provided a repair strategy to follow that is attached. Contractor shall provide all labor, material, and traffic/pedestrian control devices. Project: G Street Bridge Repair; Project number: CP230066

Check Box If Applicable To Project:
 License (1)* Type "A" _____

 Business License (2)* _____

 Bonds (6)* _____

 Insurance (13)* _____

 Workers' Compensation (14)* _____

 Prevailing Wages (15)* _____

* Numbers correspond to paragraph numbers on the Terms and Conditions attached hereto.

Consultant:**Proposal/Quote**

1. _____

2. _____

3. _____

Total Amount \$ _____

By completing and executing this document, Consultant agrees to be bound to the Terms and Conditions attached hereto and incorporated by reference, any additional terms and conditions found on the Purchase Order, and any other terms and conditions imposed by the City and attached hereto or in the Merced Municipal Code, and makes the City an offer for the above-mentioned services at the above-mentioned price. This agreement is not binding on the City until executed by the City Manager, or his/her designee, and a Purchase Order is issued to Consultant. Any terms and conditions proposed by Consultant shall not be binding upon the City unless expressly agreed to in writing by the designated representative of the City.

The individuals executing this contract represent and warrant that they have the legal capacity and authority to do so on behalf of their respective legal entities.

Consultants

Print Name**Name and Address of Business Entity****Signature**

Date: _____

Phone No.: _____

Position/Title

License No.: _____

DIR Registration No.: _____

Accepted by City of Merced*Official Use Only***City Manager or Designee**

Date _____

G STREET BRIDGE RAILING REPAIR CONCEPTS MEMORANDUM

ATTENTION: Michael Beltran, City Engineer, City of Merced, Public Works - Engineering

FROM: Jeremy Nottnagel, PE, Dokken Engineering

PROJECT: On-Call Services for Civil Engineering: – G Street Bridge Railing Repair

DATE: January 18, 2023

Purpose and Background

The purpose of this memo is to provide and recommend an alternative repair strategy to the City of Merced to repair the damaged railing along the east side of the G Street bridge. The railing and posts were damaged due to a vehicular collision and a 30ft section needs to be reconstructed.

On January 12, 2023, a site visit was performed by Dokken Engineering to review and document the limits of the damaged railing. Dokken confirmed the as-built drawings of the railing, and that the repair is limited to only a 30ft portion of the east side of the bridge, see figure 1 below. The limit of the spalled concrete for each post is described in figure 2, approximately 3'-2"x0'-7"x0'-11".



**Figure 1: Elevation View of Damaged Railing
(Looking West)**

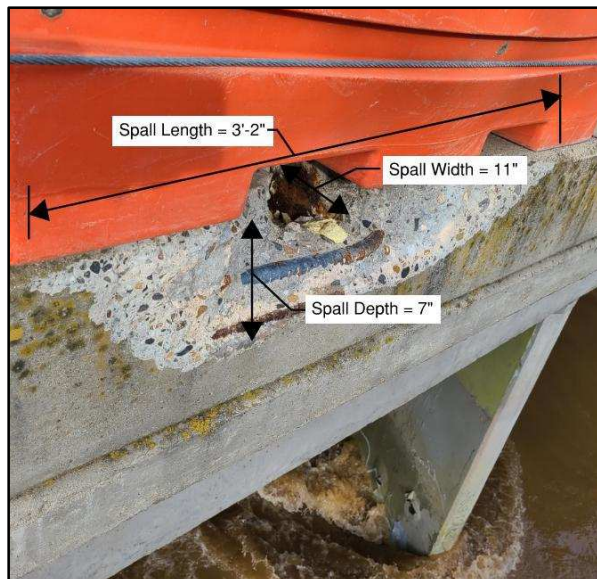

Figure 2: Spalled Concrete At Post

Repair Alternative #1: Reconstruct the Bridge Railing with Posts Placed in Post-Pockets

This repair proposes to saw cut and remove and replace the damaged concrete around the posts leaving post-pockets for the post to be installed. Once the concrete has been cast, railing posts will be placed into the post-pockets and grouted. All steel railing will be reconstructed in accordance with the as-builts, and field welded to existing undamaged railings. See Figure 3 for typical section of Alternative #1 repair strategy, see attached Repair Alternative Exhibit for additional details.

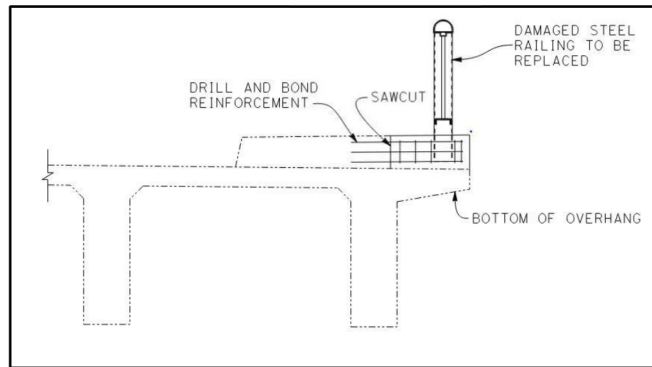
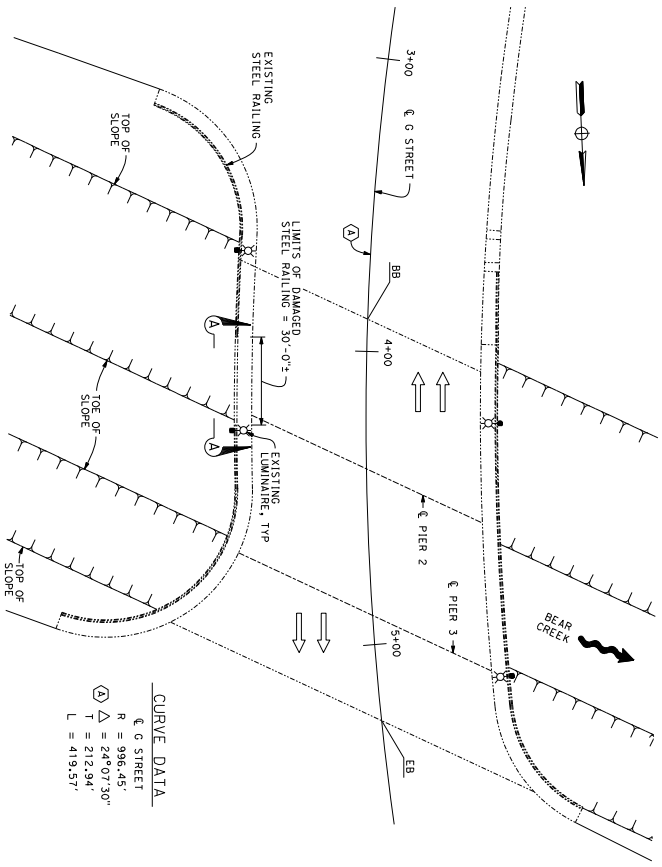

Figure 3: Repair Alternative #1 Typical Section

					Date: January 18th, 2023
ITEM NO.	ITEM DESCRIPTION	UNIT	ESTIMATED QUANTITY	PRICE	AMOUNT
1	TRAFFIC CONTROL SYSTEM	LS	1		\$
2	MINOR CONCRETE (MINOR STRUCTURE)	CY	2		\$
3	DRILL AND BOND DOWEL	LF	25		\$
4	BRIDGE REMOVAL (PORTION)	LS	1		\$
5	RECONSTRUCT METAL RAILING (BRIDGE)	LF	30		\$
6	MOBILIZATION	LS	1		\$
				Subtotal	\$
				25% Contingency	\$
				Total	\$

Table 1: Alternative Repair #1 Cost Estimate



CURVE DATA

€ G STREET
R = 996.45'
Δ = 24°07'30"
T = 212.94'
L = 419.57'

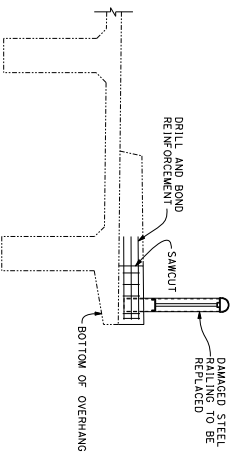
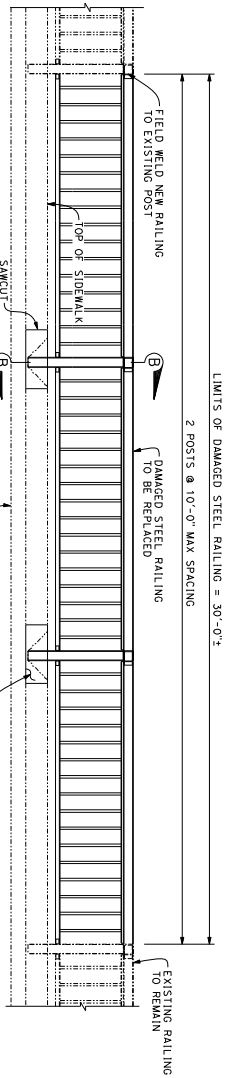

SECTION B-B
1" = 1'-0"

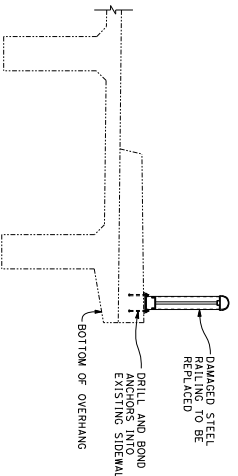

SECTION C-C
1" = 1'-0"

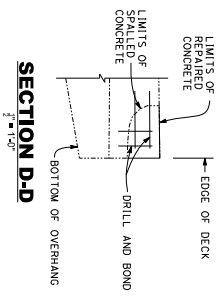

SECTION D-D
1" = 1'-0"

NO.	DATE	BY

Underground Services Alert
TWO DAYS BEFORE YOU DIG
Call 1-800-FREE 1 (800) 227-2600

NOTES:
ALL REFERENCES AND AMPLIFY INFORMATION SHALL BE TO THE PROJECT MANUAL AND SHALL BE DISCUSSED IN THE BIDDING DOCUMENTS. SHALL BE BROUGHT FORWARD TO THE CONTRACTOR FOR ANY WORK.

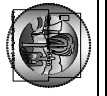

City of Merced
Engineering Department
1575 N. 18th Street (209) 386-6448

G STREET BRIDGE RAILING REPAIR

RAILING REPAIR EXHIBIT

DATE: 1/26/2023	SCALE: AS SHOWN
PROJECT: 1/26/2023	
SHEET: 1	

**TERMS AND CONDITIONS FOR
SERVICES AND
PUBLIC WORKS CONTRACTS**

THESE TERMS AND CONDITIONS, (“Terms and Conditions”) are made and entered into on the date shown on the attached Statement of Services, by and between the City of Merced, a California Charter Municipal Corporation, (“City”) and the Vendor, Consultant, or Person, (“Consultant”) shown on the Statement of Services. These Terms and Conditions, Statement of Services, and Purchase Order shall herein be collectively referred to as the “Agreement.” Any words that Consultant adds to the Agreement or any form that Consultant uses in the course of business will not change or supersede these Terms and Conditions. The City must agree, in writing, to any change in terms and conditions. The City’s acceptance of any work or services is not an acceptance of Consultant’s conflicting terms and conditions should such exist.

1. CONSULTANT QUALIFICATIONS AND STANDARD OF WORK. Consultant warrants that it is fully qualified to perform the work, and holds all applicable licenses, permits, and other necessary qualifications. Consultant shall perform and complete in a good and workmanlike manner all the work described in this Agreement to the plans and specifications provided to the Consultant by City, and shall do everything required by these Terms and Conditions and other contract documents attached hereto.

Consultant shall possess a valid A Special California Consultant’s license at the time of bid submission for the duration of the Agreement. (Applies only if marked on the Statement of Services Form).

2. CITY BUSINESS LICENSE – (Applies only if marked on the Statement of Services Form). Consultant agrees that if its business is based within the City limits or it enters into the City to conduct business then a current City of Merced business license is required. Failure to comply with this requirement could result in criminal penalties.

3. CONSULTANT’S SERVICES. Consultant shall, at its own cost and expense and as authorized and directed by the City, provide the personnel, supervision, equipment, supplies, services, administration, transportation, and other needs to complete the work described in the Statement of Services and the City’s Purchase Order, which is hereby incorporated and made a part of these Terms and Conditions, within the agreed upon time schedule and budget. The Consultant is

responsible for obtaining and administering the employment of personnel having the training, experience, licenses, and other qualifications necessary for the work assigned. All project-related costs shall be assumed and paid by the Consultant. These Terms and Conditions and Purchase Order provide the exclusive means of payment and reimbursement of costs to the Consultant by the City.

Such work shall include the following:

- a. The Consultant shall perform the services as described in the Statement of Services and Purchase Order in full compliance with these Terms and Conditions and adopted City policies and guidelines as provided to the Consultant, and in compliance with all other applicable laws and regulations.
- b. The Consultant shall perform all services and prepare all documents in professional form, exercising the special experience, skill, and education required for such service.
- c. The Consultant shall provide finished documents of presentation quality that evidence the highest standards of investigation, professional review, public participation, and presentation.

4. SCHEDULE OF PERFORMANCE AND BUDGET. The Consultant shall satisfactorily perform the services described in the Statement of Services and Purchase Order within the Time Schedule stated or agreed to between the Consultant and the City. The Consultant shall review the remaining work and remaining budget at least monthly (or at such other interval as directed by City staff) and shall confirm that completion may be expected within the budget approved or, in the alternative, give immediate notice when it shall first appear that the approved budget will not be sufficient, together with an explanation for any projected insufficiency.

The Consultant shall immediately inform the City of any problems, obstructions, or deviations of which the Consultant becomes aware affecting Consultant's ability to complete the project in a timely, efficient, and competent manner.

5. RISK OF LOSS PRIOR TO FINAL ACCEPTANCE. Risk of loss from total or partial destruction of the work, prior to final acceptance, shall be borne by Consultant regardless of the cause. Consultant shall repair or replace such damages or destroyed work to its prior undamaged condition before being

entitled to additional progress payments or final payment. Total or partial destruction or damage shall not excuse Consultant from completion of work.

6. **BONDS – (Applies only if marked on the Statement of Services Form).**

a. Consultant shall, within fifteen (15) days of contract award and before performance of the work, file a Performance Bond, with and approved by the City, in the amount of 100 percent (100%) of the contract price. The Performance Bond shall remain in effect until recordation of the Notice of Completion, or if a Notice of Completion is not recorded by the City, for sixty (60) days after completion of the work.

b. All Bonds shall be furnished by the Consultant at its own cost and expense. All bonds shall be executed by such sureties as are admitted to transact surety insurance in the State of California. Should an objection as to the sufficiency of an admitted surety on a bond be made, California Code of Civil Procedure Section 995.660 shall apply.

7. **INDEPENDENT CONSULTANT.** It is expressly understood that Consultant is an independent contractor and that its employees shall not be employees of or have any contractual relationship with the City. Consultant shall be responsible for the payment of all taxes, workers' compensation insurance and unemployment insurance. Should Consultant desire any insurance protection, the Consultant is to acquire same at its expense.

In the event Consultant or any employee, agent, or subcontractor of Consultant providing services under this Agreement is determined by a court of competent jurisdiction or the California Public Employees Retirement System (PERS) to be eligible for enrollment in PERS as an employee of the City, Consultant shall indemnify, protect, defend, and hold harmless the City for the payment of any employee and/or employer contributions for PERS benefits on behalf of Consultant or its employees, agents, or subcontractors, as well as for the payment of any penalties and interest on such contributions, which would otherwise be the responsibility of City.

8. **COMPENSATION.** Payment by the City to the Consultant for actual services rendered shall be made upon presentation of an invoice detailing services performed.

9. TERMINATION FOR CONVENIENCE OF CITY. The City may terminate the Agreement any time by mailing via certified U.S. Mail a notice in writing to Consultant that the Agreement is terminated. Alternatively, City may send said notice by facsimile with confirming notice provided via U.S. Mail. Said Agreement shall be deemed terminated as of Consultant's receipt of said notice, and no further work shall be performed by Consultant. If the Agreement is so terminated, the Consultant shall be paid for that percentage of the phase of work actually completed, based on a pro rata portion of the compensation for said phase satisfactorily completed at the time the notice of termination is received.

10. ASSIGNABILITY OF AGREEMENT. The Agreement contemplates personal performance by the Consultant and is based upon a determination of its unique personal competence and experience and upon its specialized personal knowledge. Assignments of any or all rights, duties or obligations of the Consultant under the Agreement will be permitted only with the express written consent of the City.

11. RECORDS. It is understood and agreed that all plans, studies, specifications, data magnetically or otherwise recorded on computer or computer diskettes, records, files, reports, etc., in possession of the Consultant relating to the matters covered by the Agreement shall be the property of the City, and Consultant shall deliver the same to the City upon termination of the Agreement. It is understood and agreed that the documents and other materials, including, but not limited to, those set forth hereinabove, prepared pursuant to the Agreement are prepared specifically for the City and are not necessarily suitable for any future or other use.

12. INDEMNITY. Consultant shall indemnify, protect, defend (with legal counsel selected by the City), save and hold City, its officers, employees, and agents, harmless from any and all claims or causes of action for death or injury to persons, or damage to property resulting from intentional or negligent acts, errors, or omissions of Consultant or Consultant's officers, employees, volunteers, and agents during performance of this Agreement, or from any violation of any federal, state, or municipal law or ordinance, to the extent caused, in whole or in part, by the willful misconduct, negligent acts, or omissions of Consultant or its employees, subcontractors, or agents, or by the quality or character of Consultant's work, or resulting from the negligence of the City, its officers, employees, volunteers and agents, except for loss caused by the sole negligence or willful misconduct of the City or its officers, employees, volunteers or agents. It is understood that the duty of Consultant to indemnify and hold harmless includes the duty to defend as set

forth in Section 2778 of the California Civil Code. Acceptance by City of insurance certificates and endorsements required under this Agreement does not relieve Consultant from liability under this indemnification and hold harmless clause. This indemnification and hold harmless clause shall survive the termination of this Agreement and shall apply to any damages or claims for damages whether or not such insurance policies shall have been determined to apply. By execution of this Agreement, Consultant acknowledges and agrees to the provisions of this Section and that it is a material element of consideration.

13. **INSURANCE – (Applies only if marked on the Statement of Services Form)**. During the term of the Agreement, Consultant shall maintain in full force and effect at its own cost and expense, the following insurance coverage:

- a. General Liability.
 - (i) Consultant shall obtain and keep in full force and effect general liability coverage at least as broad as ISO commercial general liability coverage occurrence Form CG 0001.
 - (ii) Consultant shall maintain limits of no less than One Million Dollars (\$1,000,000) per occurrence for bodily injury, personal injury and property damage.
 - (iii) The City, its officers, employees, volunteers and agents are to be named as additional insureds under the policy, as respects liability arising out of work or operations performed by or on behalf of the Consultant.
 - (iv) The policy shall stipulate that this insurance will operate as primary insurance for work performed by Consultant and its sub-contractors, and that any other insurance or self insurance maintained by City or other named insureds shall be excess and non-contributory.
 - (v) Consultant shall maintain its commercial general liability coverage for three (3) years after completion of the work and shall add an additional insured endorsement form acceptable to the City naming the City of Merced, its officers, employees, agents and volunteers for each year thereafter for at least three (3) years after completion of the work. Copies of the annual

renewal and additional insured endorsement form shall be sent to the City within thirty (30) days of the annual renewal.

b. Automobile Insurance.

- (i) Consultant shall obtain and keep in full force and effect an automobile policy of at least One Million Dollars (\$1,000,000) per accident for bodily injury and property damage.
- (ii) The City, its officers, employees, volunteers and agents are to be named as additional insureds under the policy, as respects automobiles owned, leased, hired or borrowed by the Consultant.
- (iii) The policy shall stipulate that this insurance will operate as primary insurance for work performed by Consultant and its sub-contractors, and that any other insurance or self insurance maintained by City or other named insureds shall be excess and non-contributory.

c. Professional Liability Insurance. Consultant shall carry professional liability insurance appropriate to Consultant's profession in the minimum amount of One Million Dollars (\$1,000,000). Architects and engineers' coverage is to be endorsed to include contractual liability.

d. Qualifications of Insurer. The insurance shall be provided by an acceptable insurance provider, as determined by City, which satisfies all of the following minimum requirements:

- (i) An insurance carrier admitted to do business in California and maintaining an agent for service of process within this State; and,
- (ii) An insurance carrier with a current A.M. Best Rating of A:VII or better (except for workers' compensation provided through the California State Compensation Fund).

e. Certificate of Insurance. Consultant shall complete and file with the City prior to engaging in any operation or activity set forth in the Agreement, certificates of insurance evidencing coverage as set forth above and which shall

provide that no cancellation or expiration by the insurance company will be made during the term of this Agreement, without thirty (30) days written notice to City prior to the effective date of such cancellation—including cancellation for nonpayment of premium. In addition to any other remedies City may have, City reserves the right to withhold payment if Consultant's insurance policies are not current.

14. **WORKERS COMPENSATION INSURANCE – (Applies Only If Marked On The Statement Of Services Form)**. Full workers' compensation insurance shall be provided with a limit of at least One Hundred Thousand Dollars (\$100,000) for any one person and as required by law, including Employer's Liability limits of \$1,000,000.00 per accident. The policy shall be endorsed to waive the insurer's subrogation rights against the City.

15. **PREVAILING WAGES – (Applies only if marked on the Statement of Services Form)**.

a. A determination of the general prevailing rates per diem wages and holiday and overtime work where the work is performed is available for review upon request at the City of Merced, located at 678 West 18th Street, Merced, California 95340. Consultant and subcontractors will not pay less than the prevailing rates of wages. Consultant will post one copy of the prevailing rates of wages at the job site.

b. Consultant shall forfeit as penalty to City the sum of Fifty Dollars (\$50.00) for each calendar day or portion thereof, and for each worker paid less than the prevailing rates under the Agreement.

16. **TRAVEL AND SUBSISTENCE PAYMENTS – (Applies only if Prevailing Wages is marked on the Statement of Services Form)**. Travel and subsistence payments shall be paid to each worker as defined in the applicable collective bargaining agreements filed with the Department of Industrial Relations for the particular craft, classification or type of work.

17. **HOURS OF WORK.**

a. Eight (8) hours of labor constitutes a legal day's work. Workers shall be paid at a rate of one and one-half times (1 ½) the basic rate of pay for work in excess of eight (8) hours during a calendar day or forty (40) hours during a calendar week for the foregoing hours.

b. Consultant shall keep and make available an accurate record showing the name of each worker, and hours worked each day and each week by each worker.

c. As a penalty to the City, Consultant shall forfeit Twenty Five Dollars (\$25.00) for each worker, including subcontractor's workers, for each calendar day during which the worker is required or permitted to work more than eight (8) hours in one (1) calendar day and forty (40) hours in any one (1) calendar week in violation of Labor Code Sections 1810 through 1815.

18. NOTICES. Notice may be given by personal delivery or by placing the notice in a properly addressed envelope and depositing that envelope in the United States mail with first-class postage paid.

19. PROHIBITION AGAINST DISCRIMINATION. In the performance of the Agreement the Consultant will not refuse or fail to hire or employ any qualified person, or bar or discharge from employment any person, or discriminate against any person with respect to the compensation, terms, conditions or privileges of employment, because of such person's race, color, creed, national origin, ancestry, sex or age.

20. PERMITS AND LICENSES.

a. Consultant shall apply for and procure permits and licenses necessary for the work.

b. Consultant shall give notices necessary and incidental to the due and lawful prosecution of the work and shall comply duly with the terms and conditions of permits and licenses.

c. Consultant shall pay charges and fees in connection with permits and licenses.

21. VENUE. The Agreement and all matters relating to it shall be governed by the laws of the State of California and any action brought relating to the Agreement shall be held exclusively in a state court in the County of Merced.

22. WAIVER. In the event that either City or Consultant shall at any time or times waive any breach of the Agreement by the other, such waiver shall not constitute a waiver of any other or succeeding breach of the Agreement, whether of

the same or any other covenant, condition or obligation. Waiver shall not be deemed effective until and unless signed by the waiving party.

23. CONFORMANCE TO APPLICABLE LAWS. Consultant shall comply with its standard of care regarding all applicable Federal, State, and municipal laws, rules and ordinances. No discrimination shall be made by Consultant in the employment of persons to work under the Agreement because of race, color, national origin, ancestry, disability, sex or religion of such person.

Consultant hereby promises and agrees to comply with all of the provisions of the Federal Immigration and Nationality Act (8 U.S.C.A. 1101 *et seq.*), as amended; and in connection therewith, shall not employ unauthorized aliens as defined therein. Should Consultant so employ such unauthorized aliens for the performance of work and/or services covered by the Agreement, and should any agency or instrumentality of the federal or state government, including the courts, impose sanctions against the City for such use of unauthorized aliens, Consultant hereby agrees to, and shall, reimburse City for the cost of all such sanctions imposed, together with any and all costs, including attorneys' fees, incurred by the City in connection therewith.