



THE WEEKLY COUNCIL INFORMATION REPORT

September 08, 2023

COMMUNITY EMERGENCY RESPONSE TEAM (CERT) BASIC TRAINING

The Merced Fire Department (MFD) kicked off the first of several CERT Basic Training courses this week. With support from the \$25,000 Listos California CERT Support Grant award, MFD reactivated its CERT Program, chartered in 2003.

Participants in this 20-hour series of classes will learn how to be part of neighborhood response teams and will be cross-trained in basic emergency skills. Each lesson emphasizes skills that will be practiced during hands-on demonstrations and exercise sessions. Sessions include disaster awareness, CERT organization and management, fire safety and utility control, medical information, search and rescue, disaster psychology, CERT communications, terrorism and refresh, and skills development and application. Classes are at Fire Station 51 and Golden Valley High School.

The department aims to train 150 community volunteers over the next six months. For more information about upcoming training sessions, contact Firefighter Diego Basulto at basultod@cityofmerced.org.

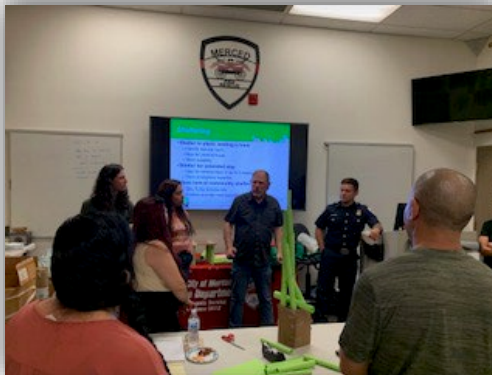

What's new at the zoo!

This week, Zookeepers welcomed a new resident to the Merced Applegate Zoo: a Chilean Rose Tarantula! The Chilean Rose Tarantula is a docile species; zookeepers can walk around the zoo with her and educate guests about the vital role of spiders in the ecosystem! She will be viewable in the Reptile Room display window when not being an animal ambassador.

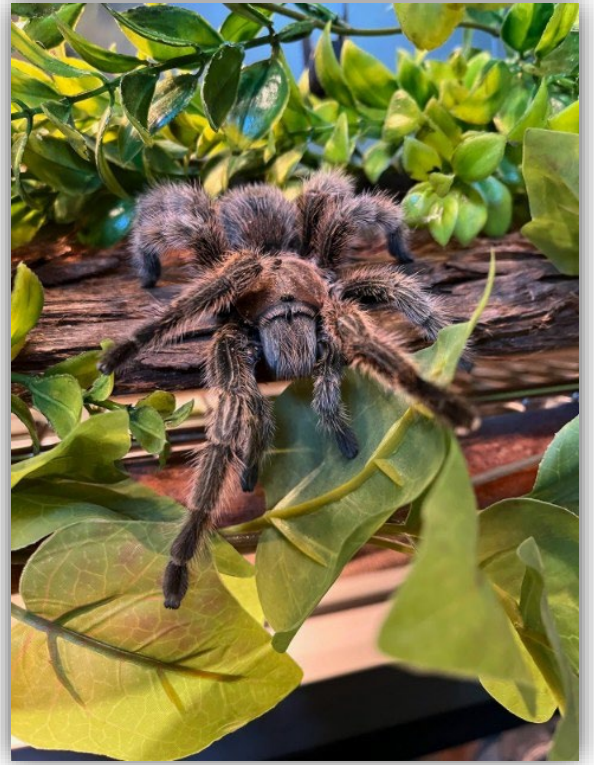

More news from the zoo!

Recently, the zoo received a delivery of fresh dirt. Zookeepers distributed the dirt around the deer, alpaca, large pond, emu, goat, and heron exhibits. With this shipment, zookeepers filled holes and leveled large areas within the exhibits to create safe and comfortable animal habitats.

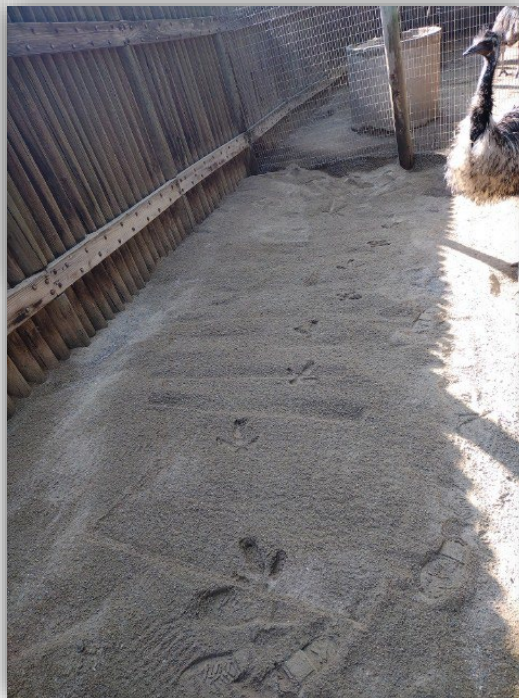

Emu Exhibit

What's new at Applegate Zoo

Saturdays and Sundays!

Join us Weekly for:

Bear Talks @ 10:15am

Join one of our Zookeepers as they explain what enrichment the bears are getting for the day and what their morning diet will be, then watch as the bears come out on exhibit and have some fun!

Coming Soon

Docent Carts

Come visit one of our carts for a fun interactive time. Touch items such as pelts, skulls, and feathers while learning more about the featured animals!

Upcoming:

◆ **OCTOBER** ZooBoo!



October 28, and 29 5:30-8:30pm

Trunk or Treat Car Show

October 28th 10am - 2pm
611 W. 22nd St. Merced

All Proceeds to benefit Zoo!

◆ **DECEMBER**

Lights Before Christmas

December 16 and 17 from 5:30-8:30pm



Follow Us @



Merced Applegate Zoo

1045 W. 25th Street Merced CA

Park Crews repaired 6” irrigation main line at Nannini Sports Complex



Tree Crews pruning along Jeorg Avenue



Contractor West Coast Arborists (WCA) started removing priority 1 trees in District 3.



Crews recently installed signs at the North Merced Transit Hub



MERCED PD'S BIKE RODEO

GRAB YOUR BIKE AND ENJOY THE OBSTACLE COURSE!



SATURDAY, SEPTEMBER 9TH

6PM-9PM

470 W 11TH ST. MERCED CA 95340

**BIKE RODEO IS A FUN WAY TO LEARN HOW TO RIDE YOUR BIKE
SAFELY! FOR ALL AGES!**

Music

Bike Repair Station

Helmet Fitting Station

**FREE Helmets while supplies
last.**

ABC'S of Bicycle Riding

Obstacle course

COFFEE WITH A COP



If you don't like coffee, don't worry there are other drink options and some delicious pastries!

Tuesday, September 12th
10:30AM- 12PM

Collaborating with:
Sensory Lab by asip
847 W Main St.
Merced Ca



Fun Fact:
As of 2019, ASIP has two locations in Suzhou and is expanding in Merced!

SUPPORT OUR LOCAL BUSINESSES!

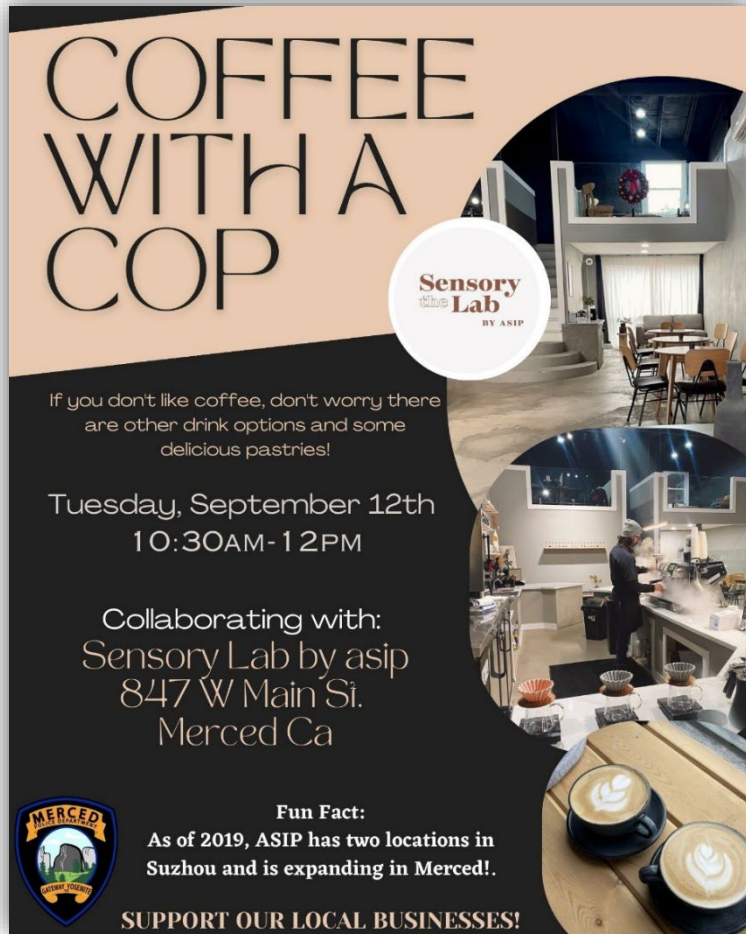

MERCED NONPROFIT ARTS COMMUNITY

MEET & GREET THE ARTS

Wednesday, September 13, 2023
5:30 pm - 7:30 pm
with a special presentation at 6:00 pm
@ the MAC: 645 W. Main Street, Merced, CA
Drinks and Appetizers will be served

Hosted by: Merced County Arts Council, UC Merced, Playhouse Merced, Merced Symphony, Merced Shakespearefest, Merced College Arts Department, Merced Historical Society and Merced Theatre Foundation





City of Merced Fire Department

TOWN HALL MEETINGS

FREE & OPEN TO THE PUBLIC

Everyone is invited to attend the meeting

Topic of Discussion

First Responder Fee Information & Education

Tuesday, October 10th
6 to 8 PM
Merced College, 3600 M Street

Thursday, October 12th
6 to 8 PM
Sam's Cafe, 235 W. 12th Street

Wednesday, October 18th
6 to 8 PM
Merced Civic Center, 678 W. 18th Street

For more information, visit www.engage.cityofmerced.org

For more information and to read the FAQs, visit www.engage.cityofmerced.org

YOU ARE INVITED TO OUR
3RD ANNUAL COPS FOR CRITTERS

TRUNK or TREAT CAR SHOW

Eventbrite

SPACE IS LIMITED,
REGISTER NOW!



ALL PROCEEDS TO BENEFIT APPLIGATE PARK AND ZOO
Saturday, Oct 28th • 10AM-2PM
611 W. 22ND St. Merced CA 95340

vehicle registration
\$25 until 10/16
after deadline \$30

Adult & Child Costumes welcome
CANDY-GAMES-MUSIC-FOOD VENDORS
&MORE!

Vendor Registration \$25



GATEWAY TO YOSEMITE
5K | 10K
RUN/WALK

RUN FOR THE RAIL
A FUNDRAISER TO BENEFIT
IMPROVEMENTS TO THE TRAIN AT
Kiddieland

SAVE THE DATE **SUNDAY NOV. 19**
7:30 AM

10K route includes out-and-back along Bear Creek Bike Path
Start and Finish near Bob Hart Square

5K ROUTE

MERCED COUNTY Office of Education
Steve M. Tinjan, S.D.S.
County Superintendent of Schools

MERCED

PARKS AND COMMUNITY SERVICES

Kiwanis
Club of Greater Merced

CULTIVA-SALUD

For more information and to register, visit
www.facebook.com/CityOfMercedParksAndRecreation

Inspection Services Bi-weekly report for August 21st, 2023, through September 3rd, 2023

Single Family Dwelling (SFD) permits:

- SFD Permits Issued: **1**
- SFD Permits in Plan Review: **251**
- SFD Certificates of Occupancy: **12**

Multi-Family Dwelling (MFD) permits in review:

- Compass Pointe phase II: 112 units in 12, 8-plex buildings, plus a clubhouse located at Compass Pointe Ave, Stinson Dr., and Horizons Ave. 2 buildings still in review.
- Affordable housing located at 3015 Park Ave.: 57,812 SF 3 story new construction, including a 2,744 SF community building. The project will provide 65 1 bedroom, 1-bathroom units and a single 2-bedroom, 1 bathroom unit.
- Two 1,336 SF duplexes located at 103 and 107 R St.
- A 4,624 SF 4-plex located at 1125 H St.
- A 2,600 SF duplex located at 531 Childs Ave.
- Emerald Village: 228 units in 18 buildings totaling 21,440 SF of living space, plus a 1,736 SF clubhouse located at 3622 N Hwy 59.
(no change since last report)

MFD permits issued:

- There were 0 multi-family permits issued during this period.
(no change since last report)

Commercial & Industrial permits issued:

- There was 1 new construction commercial permit issued during this period; for a 6,678 SF preschool located at 3670 G St.
- There were 3 new tenant improvement permits issued during this period; one for a 25,087 SF remodel at Grocery Outlet located at 1125 W. Main St., one for a 1,165 SF chiropractic office located at 3630 G St, Ste B, and one for a 1,200 SF remodel for Merced County Probation located at 600 W. Olive Ave.

Commercial & Industrial permits submitted:

- There were 0 new construction commercial permits submitted during this period.
- There were 3 new tenant improvement permits submitted during this period; one for a remodel for a food storage facility located at 1407 Merced Ave., one for a remodel for a cancer center located at 3300 M St., and one for a 3,768 SF remodel for Retinal Consultants located at 3185 M St., Ste 200.

Commercial & Industrial Certificates of Occupancy (CofOs)

- There was 1 commercial and industrial CofO issued for this period; for a 3,112 SF restaurant tenant improvement located at 125 E. Yosemite Ave. Ste A.

City of Merced
MEMORANDUM

DATE: September 7, 2023
TO: City Council
FROM: Scott McBride, Director of Development Services
SUBJECT: Actions at the Planning Commission Meeting of September 6, 2023

At their meeting of September 6, 2023, the Commission voted to recommend to the City Council the approval of Zoning Ordinance Amendment #23-04 and Environmental Review #23-27, which involves repealing Chapter 17.36 – Signs from the Merced Municipal Code and replacing Chapter 20.62 – Signs in its entirety with a comprehensive update to the ordinance that would place all sign regulations in one chapter, bring the Sign Ordinance into compliance with recent court rulings, and make the sign requirements consistent throughout the City.

The Planning Commission heard and approved a resolution to deny Conditional Use Permit #1272, a request for alcohol sales for off-site consumption for a new convenience market at 429 W. Main Street.

The Commission continued the elections of Chairperson and Vice Chairperson to the Planning Commission meeting of October 4, 2023, due to the absence of the current Chairperson.

The Commission cancelled the September 20, 2023, Planning Commission meeting due to a lack of items.

If you have any questions about these items, please feel free to contact me.

Attachments

n:shared:Planning:PCMemos

**CITY OF MERCED
Planning Commission**

Resolution #4122

WHEREAS, the Merced City Planning Commission at its regular meeting of September 6, 2023, held a public hearing and considered **Sign/Zoning Ordinance Amendment #23-04**, initiated by the City of Merced. This application involves repealing Chapter 17.36 – Signs from the Merced Municipal Code and replacing Chapter 20.62 – Signs in its entirety with a comprehensive update to the ordinance that would place all sign regulations in one chapter, bring the Sign Ordinance into compliance with recent court rulings, and make the sign requirements consistent throughout the City. The new ordinance would include new definitions, new regulations for sign area, temporary signs, digital/LED signs, signs in the public right-of-way, billboards, regional signs, freeway signs, and various other sign regulations. The proposed sign ordinance would categorize signs into four main types: permanent building signs, permanent freestanding signs, temporary building signs, and temporary freestanding signs. Each type of sign would be regulated by quantity, size, shape, type of illumination and location.

WHEREAS, the Merced City Planning Commission concurs with Findings/Considerations A through F of Staff Report #23-730 (Exhibit A); and,

NOW THEREFORE, after reviewing the City’s Draft Environmental Determination, and discussing all the issues, the Merced City Planning Commission does resolve to hereby recommend to City Council adoption of a Categorical Exemption regarding Environmental Review #23-24, and approval of Zoning Ordinance Amendment #23-04, subject to the Findings set forth in Exhibit A and as described in Exhibit B attached hereto and incorporated herein by this reference.

Upon motion by Commissioner Gonzalez, seconded by Commissioner Thao, and carried by the following vote:

AYES: Commissioners Camper, Ochoa, Gonzalez, Smith, Delgadillo, and Thao
NOES: None
ABSENT: Chairperson Harris
ABSTAIN: None

PLANNING COMMISSION RESOLUTION #4122

Page 2

September 6, 2023

Adopted this 6th day of September 2023

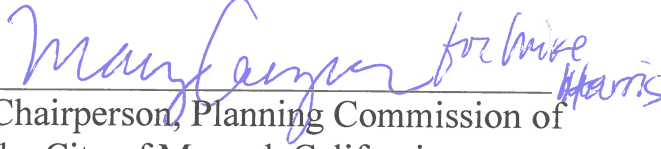
Chairperson, Planning Commission of
the City of Merced, California

ATTEST:

Secretary

Attachments:

Exhibit A – Findings

Exhibit B – Draft Ordinance

**Findings and Considerations
Planning Commission Resolution #4122
Sign/Zoning Ordinance Amendment #23-04**

FINDINGS/CONSIDERATIONS:

General Plan Compliance and Policies Related to This Application

- A) The proposed sign/zoning ordinance provided at Exhibit B of the Draft Planning Commission Resolution at Attachment A of Planning Commission Staff Report #23-730 would make changes in response to various issues regarding signage, simplify the current ordinance, incorporate all the sign regulations into one chapter within the Municipal Code, and bring the ordinance into compliance with the Supreme Court ruling regarding the Reed vs. Gilbert case. General Plan Implementing Action L-2.3.d calls for the City to review and update the Zoning and Sign Ordinances as needed.

General Overview of Proposed Changes

- B) The City of Merced is proposing a comprehensive update to the sign ordinance. This update would repeal Chapter 17.36 – Signs and incorporate all the signing regulations under Chapter 20.62 – Signs. The existing requirements in Chapter 20.62 would be replaced with the proposed new ordinance. The existing Sign Ordinance is provided at Attachment B of Planning Commission Staff Report 34-730. The intent of the update is to simplify the regulations and organize them into one Chapter of the Zoning Ordinance as well as bring them into compliance with recent Supreme Court rulings.

The proposed ordinance is written in such a way to ensure the regulations are not content based in compliance with the recent Supreme Court ruling mentioned in Finding A. The new ordinance categorizes signs into four main types:

- Permanent building signs;
- Permanent freestanding signs;
- Temporary building signs;
- Temporary freestanding signs.

Each type of subtype of sign can be separately regulated by quantity, size, shape, type of illumination, and location (i.e., zoning district or on-site/off-site) without having to read the sign or know the topic or intent of its message.

The proposed ordinance organizes the sign standards in tables based on Zoning and type of sign. It also includes pictures to help identify different types of signs as well as descriptions and graphics to determine how to measure different types of signs. Definitions are also included in the ordinance to help clearly define types of signs and terms used in the ordinance.

The proposed ordinance includes three overlay zones that would have different standards from the rest of the City. These overlay zones are: 1) the Old 99 Overlay District; 2) the Downtown Overlay District; and, 3) the Freeway Overlay District. The boundaries of each district can be found at Figures 20.62.110-1 (pg. 21), 20.62.120-1 (pg. 22) and 20.62.130-1 and 20.62.130-2 (pg. 25 and 26) of the Draft Ordinance at Exhibit B of this resolution.

The proposed ordinance also includes special standards for the following types of signs:

- Shopping Center Signs
- Signs in the Public Right-of-Way
- Temporary Signs for Residential Subdivisions
- Manual and Electronic Changeable Copy Signs
- Wall Murals
- Hazardous, Abandoned, and Illegal Signs
- Signs in Windows
- Master Sign Programs
- Historic Signs
- Flags and Search Lights
- Billboards

Comparison of Existing vs New

C) The City's consultant, QK, compared signing allowed under the existing sign ordinance and the proposed ordinance for some existing sites within the City. In most cases, the signing allowed under the proposed ordinance was very close to what would be allowed under the existing ordinance. QK will provide examples of their comparison at the Planning Commission meeting.

As previously explained, the current ordinance is located in two Chapters within the Municipal Code (Chapters 17.36 and 20.62). The existing ordinance is confusing and has different calculations for different areas within the City. The new ordinance is written to be clearer and easier to follow. The sign requirements are provided in a table format according to the zone. The table provides the type of sign allowed, the number of signs allowed, the

maximum size allowed, the sign placement, and the type of illumination allowed.

Non-Conforming Signs

- D) If the new ordinance is adopted, many existing signs within the City would become “legally non-conforming.” However, the proposed sign code allows signs that were installed legally to remain until such time as a significant change is made to the sign. At that time, the sign would be required to be in compliance with the new ordinance.

Repealing Chapter 17.36-Signs

- E) As described in Finding A above, the current requirements found in Merced Municipal Code Chapter 17.36 – Signs would be repealed as part of the update. This would allow all sign requirements to be located in one chapter (Chapter 20.62 – signs) within the Zoning Ordinance.

Environmental Clearance

- F) Planning staff has conducted an environmental review (Environmental Review #23-20) of the project in accordance with the requirements of the California Environmental Quality Act (CEQA), and recommends a Categorical Exemption (Attachment C of Planning Commission Staff Report #23-730).

City of Merced Sign Ordinance

Public Draft August 2023

Chapter 20.62 of the Merced Zoning Ordinance



Chapter 20.62

SIGNS AND OUTDOOR ADVERTISING STRUCTURES

Sections:

- 20.62.010 Purpose.**
- 20.62.020 Applicability and severability.**
- 20.62.030 No discrimination against noncommercial speech.**
- 20.62.040 Exempt signs.**
- 20.62.050 Prohibited signs.**
- 20.62.060 Required address numbers.**
- 20.62.070 Permits required.**
- 20.62.080 Sign design principles.**
- 20.62.090 Rules for sign measurement.**
- 20.62.100 Sign standards on developed sites by zone district.**
- 20.62.110 Old 99 Overlay District.**
- 20.62.120 Downtown Overlay District.**
- 20.62.130 Freeway Overlay District.**
- 20.62.140 Additional shopping center signs.**
- 20.62.150 Temporary building sign standards.**
- 20.62.152 Temporary freestanding sign standards.**
- 20.62.160 Illumination standards for signs.**
- 20.62.170 Sign regulations on undeveloped or developing sites.**
- 20.62.180 Signs placed in windows.**
- 20.62.190 Signs in public rights-of-way.**
- 20.62.200 Comprehensive master sign program.**
- 20.62.210 Offsite temporary signs for residential subdivisions.**
- 20.62.220 Historic signs.**
- 20.62.230 Signs with manual changeable copy.**
- 20.62.240 Signs with electronic changeable copy.**
- 20.62.250 Digital display signs.**
- 20.62.260 Flags and flagpoles.**
- 20.62.270 Search lights and klieg lights.**
- 20.62.280 Wall mural placement and design criteria.**
- 20.62.290 Off-premises signs in City right-of-way.**
- 20.62.300 Nonconforming signs.**
- 20.62.310 Billboards.**
- 20.62.320 Maintenance of signs.**
- 20.62.330 Hazardous signs.**
- 20.62.340 Abandoned or obsolete signs.**
- 20.62.350 Illegal Signs.**
- 20.62.360 Enforcement.**
- 20.62.370 Definitions.**

20.62.010 Purpose.

- A. The purpose of this Chapter is to regulate signs as an information system that preserves and enhances the aesthetic character and environmental values of Merced, its residential neighborhoods, its downtown, and its commercial and industrial areas, while also providing an effective means for the public to express themselves through the display of signs. These regulations recognize both the importance of business activity to the economic vitality of Merced and the need to protect the visual environment. Specifically, these regulations are intended to implement the Merced General Plan and to:
1. Provide minimum standards to safeguard life, health, property, public welfare, and traffic safety by controlling the design, quality of materials, construction, illumination, size, location, and maintenance of signs and sign structures.
 2. Preserve and enhance the visual order and attractiveness of the city for residents, businesses, and visitors.
 3. Protect and enhance property values and community appearance by encouraging signs that are compatible with the architectural style, character, and scale of the building to which they relate, and with adjacent buildings and businesses.
 4. Restrict signs that may create visual clutter or a nuisance to nearby properties, violate privacy, or create hazards or unreasonable distractions for pedestrians and drivers of vehicles.
 5. Provide adequate opportunity for the exercise of free speech by display of a message or image on a sign, while balancing that opportunity with other community and public interests.
 6. Ensure that commercial signs are accessory or auxiliary to a principal business or establishment on the same premises, rather than functioning as general advertising for hire.
 7. Prohibit signs that may cause traffic or pedestrian safety hazards or interfere with ingress and egress.
- B. It is the City of Merced’s policy to regulate signs in a constitutional manner that is content neutral as to messages, which are within the protections of the First Amendment to the U.S. Constitution and the corollary provisions of the California Constitution.

20.62.020 Applicability and severability.

This Chapter regulates signs that are located or mounted within the jurisdictional boundaries of Merced, California. The provisions in this Chapter apply in all Zoning districts within the City. No sign within the regulatory scope of this Chapter shall be erected or maintained anywhere in the City of Merced except in conformance with this Chapter. If any part, section, subsection, paragraph, subparagraph, sentence, phrase, clause, term, or word in this Chapter is declared invalid, such invalidity shall not affect the validity or enforceability of the remaining portions of the Chapter.

20.62.030 No discrimination against noncommercial speech.

Subject to the property owner’s consent, a noncommercial message of any type may be substituted, in whole or in part, for any commercial message or any other noncommercial message provided that the sign structure or mounting device is legal without consideration of message content. Such

substitution of message may be made without any additional approval or permitting. This provision prevails over any more specific provision to the contrary within this Title. The purpose of this provision is to prevent any inadvertent favoring of commercial speech over noncommercial speech or favoring of any particular noncommercial message over any other noncommercial message. This provision does not create a right to increase the total amount of signage on a parcel, nor does it affect the requirement that a sign structure or mounting device be properly permitted.

20.62.040 Exempt signs.

- A. The following signs are exempt from the permit requirements of this Chapter and do not count toward the total sign area limit for a site, provided that they conform to applicable standards:
 - 1. One permanent sign per residence or business premises, mounted on a wall and not exceeding two (2) square feet in area.
 - 2. Barber poles, not exceeding 18 inches in height, located in a non-residential zone district, and containing no lettering.
 - 3. Signs on vehicles, provided that the sign does not utilize changeable copy or special illumination.
 - 4. Holiday and cultural observance decorations on private property that do not include commercial advertising. This exemption includes strings of lights associated with a holiday decoration.
 - 5. Official notices issued by a court or public agency and posted in the performance of a public duty; notices posted by a utility or other quasi-public agency; signs erected by a governmental agency to direct or regulate pedestrian or vehicular traffic; noncommercial bus stop signs erected by a public transit agency, or other signs required or authorized by law. This exemption also covers signs and banners provided or approved by the City for special civic events erected by the City, which may be displayed in public rights-of-way.
 - 6. Signs that are located entirely within a building or enclosed structure and are not visible from the public right-of-way.
 - 7. Signs located on a private area of a lot that is not accessible by the general public, such as a backyard, and are not visible from the public right-of-way.
 - 8. Signs fixed to mobile vending carts, up to a maximum of eight (8) square feet of sign area.
 - 9. Signs that are part of a vending machine, fuel pump, or similar structure.
 - 10. Signs mounted on carrier vehicles such as buses, taxicabs, mobile vendors, and limousines that legally pass through the city.
 - 11. Window signs that conform to the standards of Section 20.62.180.
- B. Exempt signs that have electrical connections or engineered supports shall obtain the appropriate building permit, as required by the California Building Code.
- C. This chapter shall not prohibit or limit a public agency (City, County, School District, etc.) from placing signs on their public property for a public purpose.

20.62.050 Prohibited signs.

The following signs shall be prohibited in all zones:

- A. Signs located, placed, or erected in or upon any public right-of-way, except as specifically allowed by this Chapter.
- B. Signs illuminated with red, green, or amber light placed in such a position that it could reasonably be perceived to interfere with, or be confused with any official traffic control device, traffic signal, or official directional guide sign.
- C. Signs placed within the “corner vision triangle” as defined in Section 20.30.030 of the Merced Municipal Code, except for signs erected by a governmental agency to direct or regulate pedestrian or vehicular traffic.
- D. Signs placed in a location that would prevent free ingress and egress from any door, window, or fire escape.
- E. Outdoor advertising structures located on a site other than the site on which the advertised commercial use is located or on which the advertised commercial product is produced.
- F. Building signs extending above the peak of a pitched roof, or the parapet line of a flat roof.
- G. Reflecting, flashing, sparkling, glittering, twinkling, or shimmering signs.
- H. Signs with open letters that can be viewed from the reverse side.
- I. Streamers, balloons, blimps, or other floating, inflatable, or hanging devices secured with a rope or string, unless specifically permitted with a temporary use permit.
- J. Signs located, placed, or attached upon any tree, utility pole, or fence, except as specifically allowed by this Chapter.
- K. Signs placed on private property without permission of the property owner.
- L. Nonconforming signs and sign structures associated with an activity, business, product, events, or service that has not been sold, produced, provided, or conducted on the premises for a period of 90 days.
- M. Signs that revolve or are animated, except barber poles.
- N. Signs containing statements, words, symbols, or characters of an obscene nature. Obscene nature will be determined by the Development Services Director using the three-part obscenity test established in *Miller v. California*, 413 U.S. 15 (1973).
- O. Signs emitting sound.
- P. Signs located within five feet of a fire hydrant, traffic control sign, or traffic signal.
- Q. Signs over four (4) feet in height located within the “Corner Vision Triangle” area adjacent to a public street intersection as defined in Merced Municipal Code Section 20.30.030.
- R. Signs within 10 feet of a driveway or alleyway entrance or exit from the public street.

20.62.060 Required address numbers.

All commercial uses, industrial uses, and residential uses of over four (4) units shall install street address numbers of at least six (6) inches high that are clearly visible from the nearest street. Sample street address numbers shall be shown on all construction drawings for building permits and on building elevations required for any City permit. The numbers shall be considered an

architectural feature with color and/or material consistent with the building trim. Street address numbers shall not count toward the number or amount of signage allowed on a site.

20.62.070 Permits required.

- A. No sign shall be erected, altered, reconstructed, or relocated without a sign permit. A permit is not required for ordinary maintenance and repairs to signs and for temporary signs on private property that conform to the standards of this Chapter. The Development Services Director will review all applications for sign permits for consistency with this Chapter.
- B. Signs that project over or extend into a public street or sidewalk shall also require approval of an encroachment permit or license agreement by the City Engineer pursuant to the provisions of Title 12 of the Municipal Code.
- C. Consent of the property owner and business owner is required before any sign permit may be approved.

20.62.080 Sign design principles.

The following sign design principles should be used as criteria for review and approval of sign permits and master sign programs. Applications for sign permits or master sign programs that are determined by the Development Services Director to be substantially inconsistent with these sign design principles may be denied.

- A. Architectural Compatibility. A sign, including its supporting structure, if any, should be designed as an integral design element of a building’s architecture and be architecturally compatible, including color and scale, with any building to which the sign is to be attached. A sign that covers a window or that spills over “natural” boundaries or architectural features and obliterates parts of upper floors of buildings is considered detrimental to visual order and attractiveness of the city. Common indicators of compatibility are quality sign design and construction, proportional size and scale, and use of materials, shapes, textures, and colors that complement the building’s architectural style and the surrounding environment.
- B. Legibility. The size and proportion of the elements of the sign’s message, including logos, letters, icons, and other graphic images, should be based on the average distance and average travel speed of the viewer. Sign messages oriented toward pedestrians should typically be smaller than those oriented toward automobile drivers. Colors chosen for the sign text and/or graphics should have sufficient contrast with the sign background to be easily read during both day and night. Symbols and logos can be used in place of words. Signs deemed too difficult to read based on one or more of these criteria may be considered detrimental to public safety.
- C. Placement. Often, a building’s architectural details create logical places for signage. Signs should not cover or interrupt architectural details or ornaments of a building’s façade. On buildings with a monolithic or plain façade, signs should establish or continue appropriate design rhythm, scale, and proportion. Well-designed and well-located retail signs create visual interest and continuity with other storefronts on the same or adjacent buildings. Signs deemed to be architecturally incompatible based on their placement on the building may be considered detrimental to visual order and attractiveness of the City. Signs should not obstruct windows or doors except as allowed by this chapter.
- D. Materials. Signs shall be made of sturdy, durable materials. Paper, cardboard, or other material subject to rapid deterioration can only be used for signs that comply with applicable

requirements for temporary signs. Fabric signs are restricted to awnings, canopies, flags, temporary building signs, and temporary freestanding signs. Signs deemed to not be made of durable materials may be considered detrimental to both public safety and visual order and attractiveness of the City.

20.62.090 Rules for sign measurement.

A. For the purposes of this Chapter, lot frontage shall be calculated as follows:

1. If a lot fronts on two streets (excluding alleyways), both frontages shall be used to determine the allowable sign placement area.
2. If a lot fronts on three or more streets (excluding alleyways), the length of only two contiguous sides shall be added together to determine allowable sign placement area.

B. The building frontage shall be the building facade in which main customer access is provided to the establishment. Building frontage is considered continuous if projections or recesses in the building facade do not exceed 10 feet in any direction. For buildings with two or more frontages, the length of the building frontage and allowable sign placement area shall be calculated separately for each building frontage. See Figure 20.62.090-1.

**Figure 20.62.090-1
Building Frontage Calculation Examples**

Building frontage with recessed layout UNDER 10 feet in length.



Building frontage projection OVER 10 feet in length.

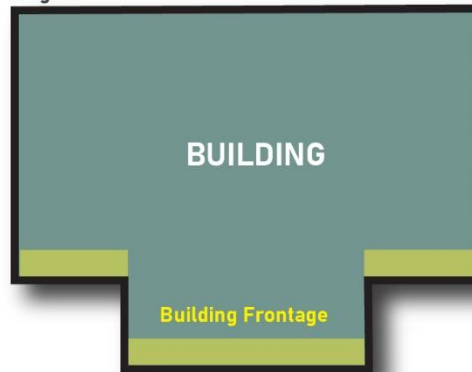

Building frontage recessed OVER 10 feet in length.

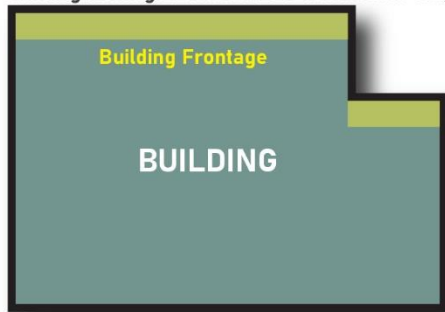

Examples of calculating building frontage length.

- C. The area of an individual sign shall be calculated as follows.
1. Sign area shall include the entire area within a single continuous perimeter composed of squares or rectangles that enclose the extreme limits of all sign elements, including, but not limited to, sign structures or borders, written copy, logos, symbols, illustrations, and color. Supporting structures such as sign bases and columns are not included in sign area provided that they contain no lettering or graphics.
 2. Where two faces of a double-faced sign are located two (2) feet or less from one another at all points or located at an interior angle of 45 degrees or less from one another, the sign area shall be calculated as the area of one (1) face. Where the two (2) faces are not equal in size, the larger sign face shall be used. Where two (2) faces of a double-faced sign are located more than two (2) feet or 45 degrees from one another, both sign faces shall be counted toward sign area.
 3. On a three-faced sign, where at least one interior angle is 45 degrees or less, the sign area shall be calculated as the sum of the largest and the smallest face. In all other situations involving a sign with three or more sides, the sign area shall be calculated as the sum of all faces.
 4. Three-Dimensional Signs. The size of signs that consist of, or have attached to them, one or more three-dimensional objects (i.e., balls, cubes, clusters of objects, sculpture, or statue-like trademarks), shall be calculated as the sum of the square footage of the two adjacent sides of the smallest theoretical cube that would encompass the sign.

Figure 20.62.090-2
Illustration of three-faced and three-dimensional signs

THREE-FACED SIGN

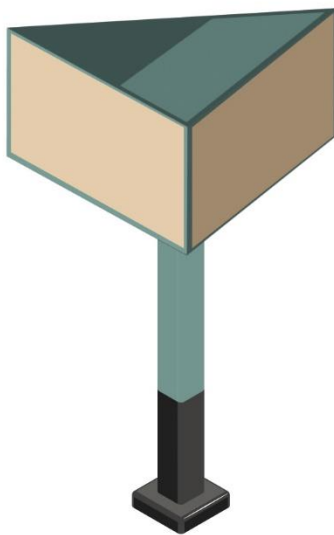

THREE-DIMENSIONAL SIGNS

D. The height of a sign shall be calculated as follows.

1. Building sign height: The height of a building sign shall be the vertical distance measured from the ground level directly beneath the sign to the highest point at the top of the sign, including any structural or architectural components of the sign.
2. Freestanding sign height: The height of a freestanding sign shall be measured as the vertical distance from grade at the edge of the right-of-way along which a freestanding sign is placed to the highest point of the freestanding sign, including any structural or architectural components of the sign. When the grade at the edge of the right-of-way is higher than the site on which the sign is placed, that portion of the sign below the grade at the edge of the right-of-way shall not be included in determining the freestanding sign's overall height. Freestanding signs oriented towards a freeway shall be measured from the site's finished grade or pad, whichever is lower.
3. Freestanding sign height clearance: Sign clearance shall be measured as the smallest vertical distance between finished grade and the lowest point of the sign, including any framework or other embellishments.
4. Shopping center signs: For the purpose of determining the allowed number and size of signs, an integrated shopping center shall be considered as one site.

E. Illustrations of rules for sign measurement are shown in Figure 20.62.090-3. If an interpretation discrepancy exists between the illustrations and the text of this Section, the text shall prevail.

**Figure 20.62.090-3
Illustration of Rules for Sign Calculation & Height Measurement**

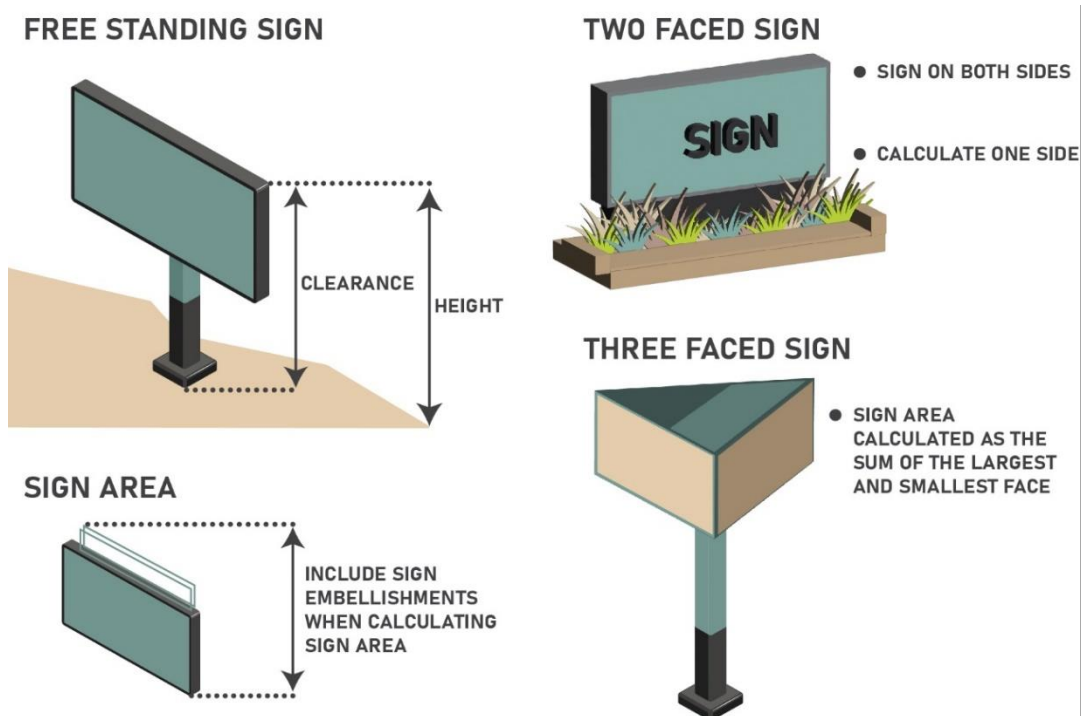

20.62.100 Sign standards on developed sites by zone district.

- A. For the purpose of this Chapter, signs are grouped into four (4) types: permanent building signs, permanent freestanding signs, temporary building signs, and temporary freestanding signs. Figure 20.62.100-1 illustrates the types of signs. The sign types are also defined in Section 20.62.360.
- B. This Section establishes standards for the number of signs, size of signs, placement of signs, and illumination of signs for developed sites based on the zone district in which the signs are located. New signs placed on private property shall conform to these standards.
1. Table 20.62.100-1 establishes sign standards for residential uses in residential zones.
 2. Table 20.62.100-2 establishes sign standards for commercial and office uses in residential zones.
 3. Table 20.62.100-3 establishes sign standards for residential uses in all non-residential zones.
 4. Table 20.62.100-4 establishes sign standards for commercial and office uses in General Commercial, Neighborhood Commercial, Shopping Center Commercial, Thoroughfare Commercial, Village Commercial, and Planned Development Zones.
 5. Table 20.62.100-5 establishes sign standards for commercial and office uses in the Regional/Central Commercial Zone.
 6. Table 20.62.100-6 establishes sign standards for commercial and office uses in Office Commercial, Business Park, and Downtown Office Zones.
 7. Table 20.62.100-7 establishes sign standards for commercial and office uses in Downtown Core and Downtown Commercial Zones.
 8. Table 20.62.100-8 establishes sign standards for commercial and office uses in Public Facility, Parks and Open Space, and Public Parking District Zones.
 9. Table 20.62.100-9 establishes sign standards for commercial, office, and industrial uses in Agriculture and Urban Transition Zones.
 10. Table 20.62.100-10 establishes sign standards for commercial, office, and industrial uses in all industrial zones.
 11. For the purpose of the tables identified in this Section, uses that are not considered residential, office, or industrial shall be considered commercial uses. This includes public assembly and community uses.
 12. Sign standards for uses within a Planned Development Zone shall be those standards in the tables in this Section established for the Zoning District that is equivalent to the site's General Plan Land Use Designation per Table 20.06-1 ("Base Zoning Districts"). Special standards for signs may be established with the adoption of the Planned Development Zone that modify and supersede the standards in this Section.

Figure 20.62.100-1
Illustration of Types of Signs



**Table 20.62.100-1
Sign Standards for Residential Uses in All Residential Zones**

Use	Type of Sign	Number of Signs	Maximum Size of Sign Face	Maximum Sign Placement	Type of Illumination
Applicable zone districts: Rural Residential, Low Density Residential, Low Medium Density Residential, Inner Village Residential, Outer Village Residential, Medium Density Residential, High Density Residential, Mobile Home Residential, and Residential Planned Development					
One to four residences on the parcel	Permanent Building Sign	1 per residence	2 square feet	8 feet	External illumination or internal illumination allowed in accordance with section 20.62.160
	Permanent Freestanding Sign	No permanent freestanding signs allowed	N/A	N/A	N/A
	Temporary Building Sign	1 per parcel	12 square feet	2 feet below bottom of roofline	No illumination
	Temporary Freestanding Sign	Up to 1 per unit on the property	Up to 4 square feet	Up to 2 feet high	No illumination
More than four residences on the parcel	Permanent Building Sign	1 for each street frontage that is longer than 25 feet, up to a maximum of 2 signs, plus 1 additional sign if cumulative street frontage is more than 400 feet	24 square feet per sign	20 feet above base of building	External & internal illumination allowed in accordance with section 20.62.160
	Permanent Freestanding Sign	1 per public driveway entrance. The sign must be a monument sign, except within the Old 99 and Freeway Overlay Districts.	24 square feet	6 feet except no higher than 4 feet unless it is outside the Corner Vision Triangle Area	External & internal illumination allowed in accordance with section 20.62.160
	Temporary Building Sign	Up to 2 per parcel	16 square feet cumulative of all temporary signs	2 feet below bottom of roofline	No illumination
	Temporary Freestanding Sign	Up to 5 per parcel	1 sign up to 16 square feet, all others up to 4 square feet	1 sign up to 5 feet high, all others up to 3 feet high	No illumination

**Table 20.62.100-2
Sign Standards for Commercial and Office Uses in All Residential Zones**

Use	Type of Sign	Number of Signs	Maximum Size of Sign Face	Maximum Sign Placement	Type of Illumination
<p>Applicable zone districts: Rural Residential, Low Density Residential, Low Medium Density Residential, Inner Village Residential, Outer Village Residential, Medium Density Residential, High Density Residential, Mobile Home Residential, and Residential Planned Development</p>					
Commercial and office uses	Permanent Building Sign	1 per building frontage. New can or cabinet signs are not allowed as a sign type if sign is internally illuminated.	1 square foot per lineal building frontage on the main frontage, and 1/2 square foot per lineal building frontage on other allowed building frontages	2 feet below height of building wall	External & internal illumination allowed in accordance with section 20.62.160
	Permanent Freestanding Sign	1 per parcel. The sign must be a monument sign, except within the Old 99 and Freeway Overlay Districts.	24 square feet	6 feet except no higher than 4 feet unless it is outside the Corner Vision Triangle Area	External & internal illumination allowed in accordance with section 20.62.160
Commercial and office uses	Temporary Building Sign	1 sign regardless of number of residential units on the parcel	4 square feet	2 feet below bottom of roofline	No illumination
	Temporary Freestanding Sign	1 per parcel	4 square feet	3 feet high	No illumination

**Table 20.62.100-3
Sign Standards for Residential Uses in Non-residential Zones**

Use	Type of Sign	Number of Signs	Maximum Size of Sign Face	Maximum Sign Placement	Type of Illumination
<p>Applicable zone districts: General Commercial, Neighborhood Commercial, Shopping Center Commercial, Thoroughfare Commercial, Village Commercial, Regional/Central Commercial, Office Commercial, Business Park, Downtown Core, Downtown Office, Downtown Commercial, Public Facility, Public Parking District, Parks and Open Space, Agriculture, Urban Transition, Light Industrial, Heavy Industrial, and Planned Development</p>					
Residential uses	Permanent Building Sign	1 sign regardless of the number of residential units on the parcel	1 square foot per lineal building frontage on the main frontage, and 1/2 square foot per lineal building frontage on other allowed building frontages	8 feet	Internal illumination allowed in accordance with section 20.62.160
	Permanent Freestanding Sign	1 per residential driveway entrance. The sign must be a monument sign, except within the Old 99 and Freeway Overlay Districts.	24 square feet	10 feet except no higher than 4 feet unless it is outside the Corner Vision Triangle Area	External & internal illumination allowed in accordance with section 20.62.160
	Temporary Building Sign	1 sign regardless of number of residential units on the parcel	4 square feet	2 feet below bottom of roofline	No illumination
	Temporary Freestanding Sign	1 per parcel	4 square feet	3 feet high	No illumination

**Table 20.62.100-4
Sign Standards for Commercial and Office Uses in General Commercial, Neighborhood Commercial, Shopping Center Commercial, Thoroughfare Commercial, Village Commercial, and Planned Development Zones**

Use	Type of Sign	Number of Signs	Maximum Size of Sign Face	Maximum Sign Placement	Type of Illumination
Applicable zone districts: General Commercial, Neighborhood Commercial, Shopping Center Commercial, Thoroughfare Commercial, Village Commercial, and Planned Development					
Commercial and office uses	Permanent Building Sign	No maximum number. New can or cabinet signs are not allowed as a sign type.	1 square foot per 1 lineal foot on the main building frontage up to a maximum of 350 square feet, and 1/2 square feet per 1 lineal foot on other allowed building frontages up to a maximum of 100 square feet	2 feet below height of building	External & internal illumination allowed in accordance with section 20.62.160
	Permanent Freestanding Sign for Individual Businesses. See note below.	1 per each street frontage longer than 25 feet. The sign must be a monument sign, except within the Old 99 and Freeway Overlay Districts.	40 square feet per face.	8 feet except no higher than 4 feet unless it is outside the Corner Vision Triangle Area	External & internal illumination allowed in accordance with section 20.62.160
	Temporary Building Sign	1 for each business establishment or separate use with an exterior building wall	16 feet per sign	2 feet below bottom of roofline or parapet	External illumination allowed in accordance with section 20.62.160
	Temporary Freestanding Sign	1 for each business establishment or separate use with an exterior building wall; if there are more than 4 businesses on the site, then 1 additional sign for every street frontage	4 square feet for each separate business; 32 square feet for the 1 additional sign for each street frontage	3 feet high for each separate business sign; 8 feet for the 1 additional sign for each street frontage	External illumination allowed in accordance with section 20.62.160

NOTE: In addition to the above, “Shopping Center Signs” are allowed per the provisions of Section 20.62.140.

**Table 20.62.100-5
Sign Standards for Commercial and Office Uses in the Regional/Central Commercial and
Planned Development Zones**

Use	Type of Sign	Number of Signs	Maximum Size of Sign Face	Maximum Sign Placement	Type of Illumination
Applicable zone districts: Regional/Central Commercial and Planned Development					
Commercial and office uses	Permanent Building Sign	1 per building frontage that does not face a residential use. New can or cabinet signs are not allowed as a sign type.	1.5 square feet per 1 lineal foot on the main building frontage up to a maximum of 500 square feet, and 1/2 square feet per 1 lineal foot on other allowed building frontages up to a maximum of 200 square feet	2 feet below height of building	External & internal illumination allowed in accordance with section 20.62.160
	Permanent Freestanding Sign for Individual Businesses. See note below.	1 per each street frontage longer than 25 feet The sign must be a monument sign, except within the Old 99 and Freeway Overlay Districts.	40 square feet per face.	8 feet except no higher than 4 feet unless it is outside the Corner Vision Triangle Area	External & internal illumination allowed in accordance with section 20.62.160
	Temporary Building Sign	1 for each business establishment or separate use with an exterior building wall	16 square feet per sign	2 feet below bottom of roofline or parapet	External illumination allowed in accordance with section 20.62.160
	Temporary Freestanding Sign	No more than 2 per parcel frontage (otherwise would be way too many for the Mall or other large centers)	4 square feet for each	4 feet	External illumination allowed in accordance with section 20.62.160

NOTE: In addition to the above, “Shopping Center Signs” are allowed per the provisions of Section 20.62.140.

**Table 20.62.100-6
Sign Standards for Commercial and Office Uses in Office Commercial, Business Park, and
Downtown Office Zones**

Use	Type of Sign	Number of Signs	Maximum Size of Sign Face	Maximum Sign Placement	Type of Illumination
Applicable zone districts: Office Commercial, Business Park, Downtown Office, and Planned Development					
Office and Commercial uses, i.e., all non-residential uses	Permanent Building Sign	1 per building plus 1 for each tenant with more than 20 feet of building frontage. New can or cabinet signs are not allowed as a sign type.	35 square feet per sign, or 50 square feet if two or more allowed signs are combined into 1 shared sign	4 feet below height of building	Internal illumination allowed in accordance with section 20.62.160
	Permanent Freestanding Sign for individual businesses. See note below.	1 per parcel. The sign must be a monument sign, except within the Old 99 and Freeway Overlay Districts.	24 square feet	6 feet except no higher than 4 feet unless it is outside the Corner Vision Triangle Area	Internal illumination allowed in accordance with section 20.62.160
	Temporary Building Sign	1 for each business establishment or separate use with an exterior building wall	16 square feet per sign	2 feet below bottom of roofline or parapet	No illumination
	Temporary Freestanding Sign	1 for each business establishment or separate use with an exterior building wall; If there are more than 4 businesses on the site, then 1 additional sign for every street frontage	4 square feet for each separate business; 32 square feet for the 1 additional sign for each street frontage	3 feet high for each separate business sign; 8 feet for the 1 additional sign for each street frontage	No illumination

NOTE: In addition to the above, “Shopping Center Signs” are allowed per the provisions of Section 20.62.140.

**Table 20.62.100-7
Sign Standards for Commercial and Office Uses in Downtown Core and Downtown Commercial Zones**

Use	Type of Sign	Number of Signs	Maximum Size of Sign Face	Maximum Sign Placement	Type of Illumination
Applicable zone districts: Downtown Core, Downtown Commercial					
Commercial and office uses, i.e., all non-residential uses	Permanent Building Sign	1 per building frontage that does not face a residential use (excluding blade signs). New can or cabinet signs are not allowed as a sign type	1 square foot per 1 lineal foot of building up to a maximum of 75 square feet;	1 foot below height of building	External & internal illumination allowed in accordance with section 20.62.160
	Permanent Freestanding Sign	No permanent freestanding signs allowed	No permanent freestanding signs allowed	No permanent freestanding signs allowed	No permanent freestanding signs allowed
	Temporary Building Sign	1 per tenant	16 square feet	2 feet below bottom of roofline or parapet	No illumination
	Temporary Freestanding Sign	Not allowed unless within Downtown overlay zone; See Section 20.62.110	10 square feet per side	6 feet	External illumination allowed in accordance with section 20.62.160

**Table 20.62.100-8
Sign Standards* for Commercial and Office Uses in Public Facility, Parks and Open Space,
and Public Parking District Zones**

Use	Type of Sign	Number of Signs	Maximum Size of Sign Face	Maximum Sign Placement	Type of Illumination
Applicable zone districts: Public Facility, Parks and Open Space, Public Parking District					
Commercial and office uses,	Permanent Building Sign	1 per building plus 1 for each tenant with more than 20 feet of building frontage. New can or cabinet signs are not allowed as a sign type.	35 square feet per sign, or 50 square feet if two or more allowed signs are combined into 1 shared sign	4 feet below height of building	External illumination allowed in accordance with section 20.62.160
	Permanent Freestanding Sign	1 per driveway entrance. The sign must be a monument sign, except within the Old 99 and Freeway Overlay Districts.	24 square feet	6 feet except no higher than 4 feet unless it is outside the Corner Vision Triangle Area	External & internal illumination allowed in accordance with section 20.62.160
	Temporary Building Sign	No specific limit – As needed to perform public functions	No specific limit – As needed to perform public functions	2 feet below bottom of roofline or parapet	No illumination
	Temporary Freestanding Sign	No specific limit – As needed to perform public functions	No specific limit – As needed to perform public functions	No specific limit – As needed to perform public functions	No illumination

*Standards do not apply to City of Merced signage.

**Table 20.62.100-9
Sign Standards for Commercial, Office, and Industrial Uses in Agriculture and Urban Transition Zones**

Use	Type of Sign	Number of Signs	Maximum Size of Sign Face	Maximum Sign Height	Type of Illumination
Applicable zone districts: Agriculture, Urban Transition					
Commercial, office, and industrial uses,	Permanent Building Sign	1 per building	25 square feet	8 feet	External & internal illumination allowed in accordance with section 20.62.160
	Permanent Freestanding Sign	1 per parcel. The sign must be a monument sign, except within the Old 99 and Freeway Overlay Districts.	24 square feet	6 feet except no higher than 4 feet unless it is outside the Corner Vision Triangle Area	External illumination allowed in accordance with section 20.62.160
	Temporary Building Sign	1 for each business establishment or separate use with an exterior building	16 square feet per sign	2 feet below bottom of roofline or parapet	No illumination
	Temporary Freestanding Sign	1 for each business establishment or separate use with an exterior building wall. If there are more than 4 businesses on the site, then 1 additional sign for every street frontage.	4 square feet for each separate business. 32square feet for the 1 additional sign for each street frontage	3 feet high for each separate business sign. 8 feet for the 1 additional sign for each street frontage	No illumination

**Table 20.62.100-10
Sign Standards for Commercial, Office, and Industrial Uses in All Industrial Zones**

Use	Type of Sign	Number of Signs	Maximum Size of Sign Face	Maximum Sign Height	Type of Illumination
Applicable zone districts: Light Industrial, Heavy Industrial					
Industrial, Commercial, and office uses, i.e., all non-residential uses	Permanent Building Sign	Up to 3 per building	1 square foot for each lineal foot of street frontage up to a maximum of 500 square feet; maximum size is for the sum of all signs	2 feet below height of building	External & internal illumination allowed in accordance with section 20.62.160
	Permanent Freestanding Sign	1 per driveway entrance. The sign must be a monument sign, except within the Old 99 and Freeway Overlay Districts.	24 square feet	10 feet except no higher than 4 feet unless it is outside the Corner Vision Triangle Area	External & internal illumination allowed in accordance with section 20.62.160
	Temporary Building Sign	1 for each business establishment or separate use with an exterior building wall	16 square feet per sign	2 feet below bottom of roofline or parapet	No illumination
	Temporary Freestanding Sign	1 for each business establishment or separate use with an exterior building wall; if there are more than 4 businesses on the site, then 1 additional sign for every street frontage	4 square feet for each separate business; 32 square feet for the 1 additional sign for each street frontage	3 feet high for each separate business sign; 8 feet for the 1 additional sign for each street frontage.	No illumination

20.62.110 Old 99 Overlay District.

A. The sign standards in Section 20.62.100 are modified in accordance with this Section for parcels located within the Old 99 Overlay District. The area of Old 99 Overlay District is defined as the area shown in Figure 20.62.110-1.

**Figure 20.62.110-1
Old 99 Overlay District Boundary**

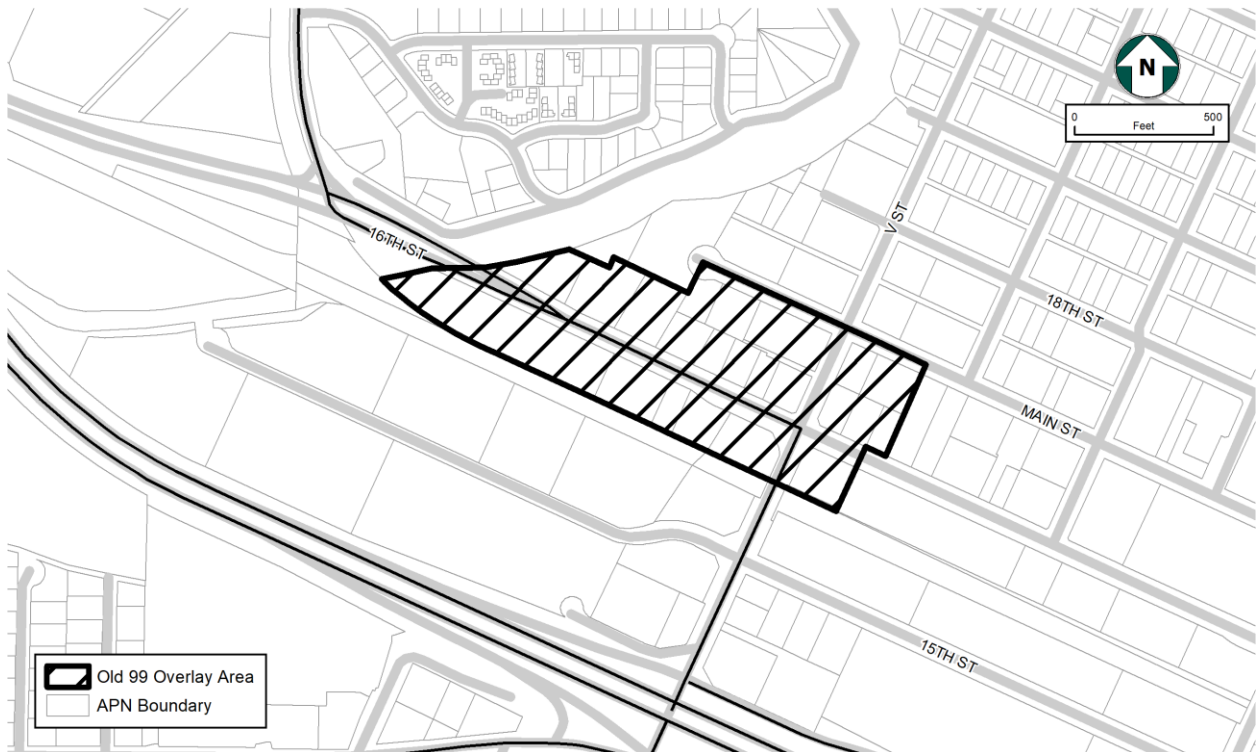

B. In addition to the signs allowed in Section 20.62.100, parcels located within the Old 99 Overlay District are allowed one (1) permanent freestanding sign not to exceed 200 square feet with a maximum height of 25 feet. The sign may be internally or externally illuminated. This sign shall be in addition to the signs allowed by Section 20.62.100.

20.62.120 Downtown Overlay District.

- A. The sign standards for non-residential uses in Section 20.62.100 are superseded by this Section for parcels located within the Downtown Overlay District. The area of the Downtown Overlay District is defined as the area shown in Figure 20.62.120-1.

**Figure 20.62.120-1
Downtown Overlay District Boundary**



- B. In place of signs allowed in Section 20.62.100, this Section establishes standards for the number of signs, size of signs, placement of signs, and illumination of signs for non-residential uses in the Downtown Overlay District. Table 20.62.120-1 establishes specific regulations for non-residential uses for permanent building signs, permanent freestanding signs, temporary building signs, and temporary freestanding signs.
- C. In addition to signs allowed in Section 20.62.100, one (1) additional permanent building sign oriented to pedestrians may be allowed up to 10 square feet. The sign type is limited to a projecting sign or an arcade or hanging sign. A minimum 8-foot clearance shall be provided under signs hanging over pedestrian paths of travel.
- D. In addition to signs allowed in Section 20.62.100, window signs placed on the inside of the window are allowed. Signs shall not cover more than 20 percent of the window.

Table 20.62.120-1

Sign Standards for Non-residential uses in the Downtown Overlay District

Type of Sign	Number and Type of Signs	Maximum Size of Sign Face	Maximum Sign Height	Type of Illumination
Applicable to non-residential uses in the Downtown Overlay District:				
Permanent Building Sign	Maximum size of sign per frontage is cumulative and may be 1 sign or divided into multiple signs. New can or cabinet signs are not allowed as a sign type. Signs may include awning signs, blade signs in accordance with Section 20.62.120(E), or canopy-mounted signs	1 square foot per 1 lineal foot of building frontage if a multi-story building contains non-residential uses in one of the upper floors, the maximum sizes shall be increased by 50 percent	2 feet below the roofline or parapet for single-story buildings; No more than 15 feet above the roofline for multi-story buildings	Internal illumination allowed in accordance with section 20.62.130
Permanent Freestanding Sign	1 permanent freestanding signs allowed only if the building does not directly front on the public sidewalk	24 square feet	6 feet except no higher than 4 feet unless it is outside the Corner Vision Triangle Area	Internal illumination allowed in accordance with section 20.62.130
Temporary Building Sign	1 per business; all corners of the signs shall be attached to the building	16 square feet	2 feet below the roofline or parapet for single-story buildings; 30 feet for multi-story buildings	No illumination
Temporary Freestanding Sign	1 per business; sign type limited to A-frame or structurally similar type of sign placed on the site or adjacent sidewalk within 15 feet of the building entrance; sign shall be placed so that a minimum 4-foot-wide pedestrian path of travel is maintained on the sidewalk	10 square feet per side	6 feet	No illumination

- E. Blade signs are counted towards the maximum allowed permanent building sign area for a particular parcel. Blade signs may be permitted in Downtown Overlay District, by an application for administrative staff review through the planning department, if the following requirements are met:
1. A blade sign must have a vertical clearance of eight (8) feet above the sidewalk or other public right-of-way and cannot exceed a height of more than six (6) feet above the height of the entryway of the building on which the sign is mounted or as otherwise approved by the planning commission through the approval of a comprehensive master sign program.
 2. A blade sign shall not exceed five (5) square feet of signage per side, shall be placed at least six (6) inches away from the building wall and the edge of the sign nearest the building, and shall not project more than 42 inches from the building wall on which it is mounted.
 3. A blade sign must be attached by a wrought iron or similar metal framework to the building wall. Materials, color, and arrangement of the sign shall be compatible and consistent with the building and neighboring structures.

20.62.130 Freeway Overlay District.

- A. The sign standards in Section 20.62.100 are modified in accordance with this Section for parcels located within the Freeway Overlay District. The Freeway Overlay District is defined as the area shown in Figure 20.62.130-1 and Figure 20.62.130-2.
- B. In addition to the signs allowed in Section 20.62.100, parcels in the Freeway Overlay District with a commercial use may, upon issuance of a freeway-oriented sign permit, establish a pole sign or a pylon sign consistent with the following standards:
1. There shall be a maximum of one such pole or pylon sign per parcel.
 2. The sign shall have a maximum of two sides.
 3. The maximum size shall be 100 square feet per side.
 4. The maximum height shall be 90 feet.
 5. The sign shall be set back a minimum of 10 feet from all property lines and rights-of-way.
 6. The sign shall be set back a minimum 40 feet from any residential zone district.
 7. The sign shall be located in a landscaped planter at least three (3) feet wider than the base of the sign on all sides. The planter may encroach into the required minimum sign setback areas.
- C. In lieu of the single sign allowed in Subsection B above, up to six (6) multiple commercial uses that are located on the same parcel or uses that are located on adjacent parcels may, upon issuance of a freeway-oriented sign permit, establish a pylon sign consistent with the following standards:
1. There shall be a maximum of one such pole or pylon sign per parcel.
 2. The sign shall have a maximum of two sides.
 3. The maximum size shall be 100 square feet per commercial use per side.
 4. The maximum height shall be 90 feet.

5. The sign shall be set back a minimum of 15 feet from all property lines and rights-of-way.
 6. The sign shall be set back a minimum 80 feet from any residential zone district.
 7. The sign shall be located in a landscaped planter at least three (3) feet wider than the base of the sign on all sides. The planter may encroach into the required minimum sign setback areas.
- D. Freeway-oriented signs may be internally lit but shall not be externally lit. Signs must be compliant with Chapter 2 of the California Manual on Uniform Traffic Control Devices (MUTCD) which contains guidance for signs on highways and private roads.

Figure 20.62.130-1
Freeway Overlay District Boundary – Part 1

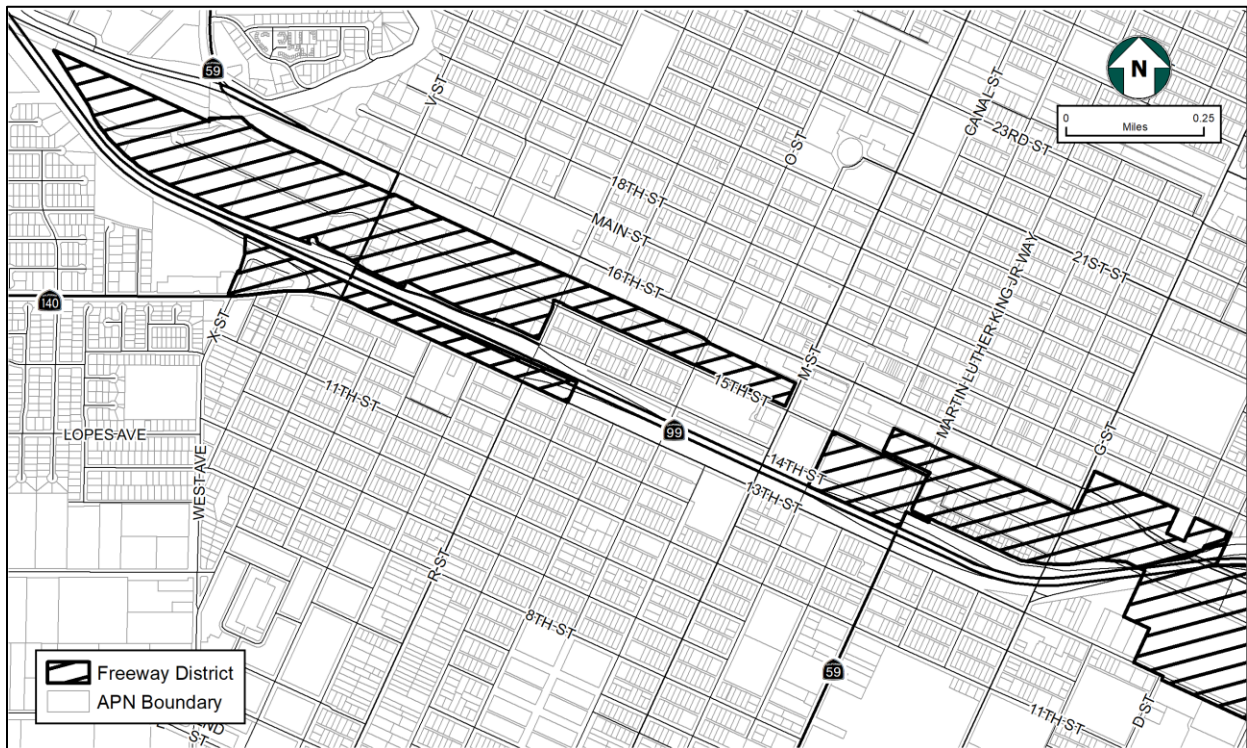
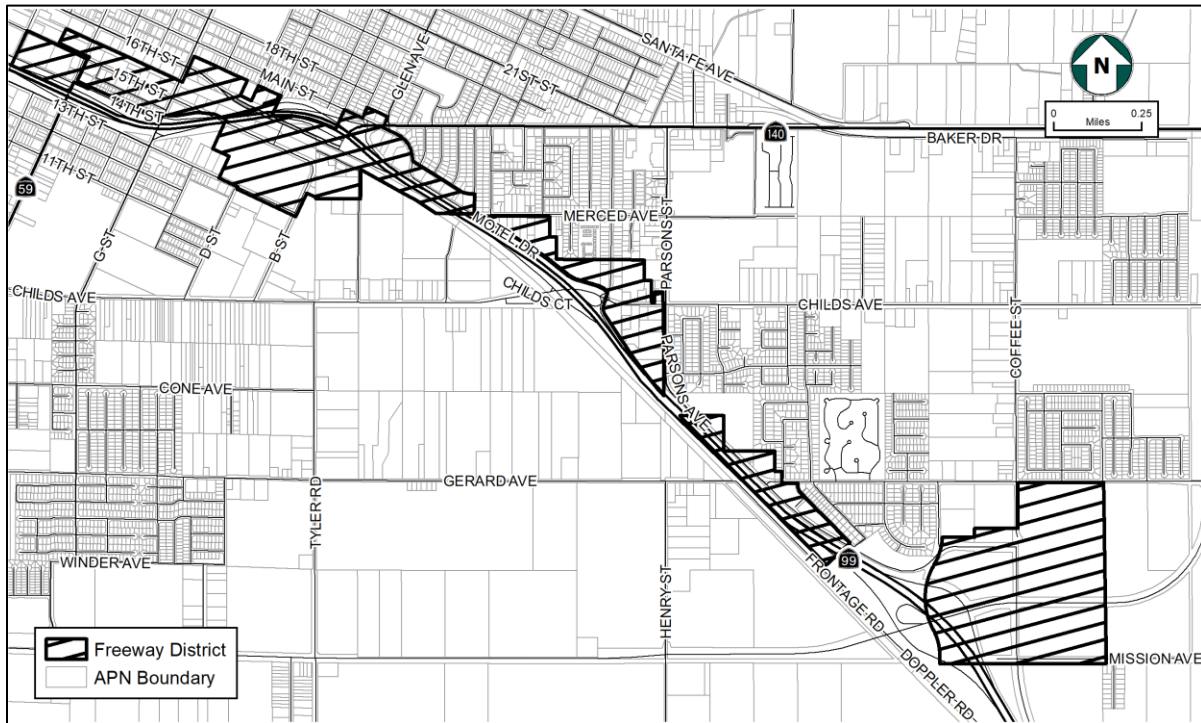

Figure 20.62.130-2
Freeway Overlay District – Part 2



20.62.140 Additional shopping center signs.

- A. Shopping centers or office complexes with a mix of retail and/or professional office tenants having a combined total of 25,000 square feet or more of gross floor area and located within a commercial zone and a P-D zone may be allowed an additional permanent freestanding or permanent building sign beyond what is allowed in Section 20.62.100 if the sign conforms to the following provisions:
 - 1. The shopping center sign may advertise the name of the center, the tenants in the center, or both the center and tenant names. Tenant advertising on a shopping center sign is not counted as part of the overall sign area permitted by Table 20.62.100-4. The area of the name of the shopping center is in addition to the permitted copy area. Only advertising for businesses located on the parcel is allowed.
 - 2. The sign may be illuminated unless adjacent to residential uses, in which case the Development Services Director may require conditions on the type of illumination to protect against negative effects on the adjacent residential uses. The sign must be constructed of a material that is compatible with the texture and materials of the shopping center buildings. Individual letters and logos may be internally illuminated.
 - 3. Materials, color, and arrangement shall be compatible and consistent with the shopping center buildings.
 - 4. A maximum of two (2) shopping center signs on one (1) arterial street may be allowed. At least 400 feet of combined arterial street frontage is required to qualify for one (1) sign,

except that shopping centers existing at the time of adoption of this Section meeting all other requirements of this Section are not bound by this requirement. An additional eight hundred (800) feet of frontage is required for a second sign.

5. The maximum height and size allowances for shopping center signs are different in the Neighborhood Commercial (C-N), Thoroughfare Commercial (C-T), and Regional/Community Commercial (R-C) land use designations or Planned Developments with the equivalent General Plan designation. See Table 20.62.140-1 below:

**Table 20.62.140-1
Shopping Center Sign Size**

	Neighborhood Commercial / Thoroughfare Commercial	Regional / Community Commercial
Maximum Height (as measured from top of sidewalk or curb)	12.5 feet plus 2 feet for appurtenances	25 feet high plus 3 feet for appurtenances
Structure Area	12.5 feet high maximum by 8 feet wide maximum. 100 square feet per face maximum.	20 feet high maximum by 13 feet wide maximum. 260 square feet per face maximum.
Sign Area	50% of Structure Area, not to exceed 50 square feet per face	50% of Structure Area, not to exceed 130 square feet per face

6. A minimum of 10 square feet is required for each tenant displayed on a shopping center sign.
 7. The width of the foundation base of a shopping center permanent freestanding sign shall be a minimum of 80 percent of the sign face.
 8. The sign structure shall have a minimum three-foot setback from any property line.
 9. A building permit application to construct a shopping center sign shall be signed by all property owners of the shopping center.
- B. With the adoption of a comprehensive master sign program in accordance with Section 20.62.180, a shopping center or office complex with a mix of retail and/or professional office tenants may be eligible for "bonus" sign area greater than allowed under an overall sign area permitted by Section 20.62.100.650.
1. A "bonus" of up to 30 percent shall be granted if a permanent copy is included on the shopping center sign that states "City of Merced," "Welcome to Merced," or equivalent language, as approved by the planning commission.
 2. A "bonus" of up to 60 percent may be granted, pending approval by the planning commission, if enhanced design features (such as additional landscaping, water features, decorative artwork, seating areas, etc.) are incorporated into the shopping center.

3. A “bonus of up to 70 percent may be granted if the criteria of both "a" or "b" above are met.
4. A "bonus" which would allow a "changeable copy sign" of no more than 50 percent of the total sign area to be incorporated into the shopping center sign; and if the owner agrees to allow the city to advertise city or community/city sponsored events, at the discretion of the city, on the sign on a continuous and ongoing basis as part of a continuous rotation of advertising or as otherwise defined by the planning commission. The planning commission may increase the total sign area and/or reduce the amount of city advertising for unique circumstances, such as motion picture/performing arts theaters. Other than those city events above, the changeable copy sign shall not advertise any business, commodity, service, industry, or other activity, which is not sold, offered, or conducted on the premises upon which the sign is located or affixed.
5. A "bonus" consisting of an increased maximum allowable height of a shopping center sign, not to exceed 50 percent of the maximum allowable height spelled out in the table in Section 17.36.667.E, may be granted, pending approval by the Planning Commission, if the criteria for either "a" or "b" above are met and/or if the shopping center is located on the corner of two (2) arterial streets, as defined in the Merced General Plan.

20.62.150 Temporary building sign standards.

- A. Temporary building signs in non-residential zones shall only be allowed for a total of six (6) months in any 12-month period for any single parcel or business.
- B. Temporary building signs in non-residential zones over 4 square feet in size that will be in place for more than 30 days shall require a temporary sign permit. With such a permit, the signs may be up to 30 square feet in size and may be in place for up to 6 months.
- C. Feather banners, balloons, and banners shall not be used as permanent signs.
- D. Temporary building signs shall not be internally illuminated.

20.62.152 Temporary freestanding sign standards.

- A. Feather banners and balloons will be allowed only for grand openings and are not to exceed being on display in excess of 30 days.
- B. Feather banners and balloons shall not be used as permanent signs.
- C. Banners and feather banners shall be constructed of durable, weather-resistant materials not subject to rapid deterioration or fading and shall be professional in appearance. Acceptable materials include but are not limited to vinyl, nylon-reinforced vinyl, polyethylene or polyester-like materials, or durable fabric.
- D. Temporary freestanding signs in non-residential zones shall not be placed in the following locations:
 1. In any public right-of-way, including sidewalks, except as allowed by Section 10.62.110 in the Downtown Overlay District.
 2. In parking lot driving lanes, drive aisles, or parking spaces.
 3. On multi-use trails or sidewalks on private property if they would block a four-foot-wide pedestrian path of travel.

4. Any location where the sign would block the pedestrian path of travel or access to a building.
 5. Within 20 feet on either side or in front of a permanent freestanding sign.
 6. Within 20 feet of an adjoining property line.
 7. Within 20 feet from any other temporary freestanding sign.
 8. Within five (5) feet of a public right-of-way.
- E. Temporary freestanding signs shall be affixed to supporting structures made of a durable, rigid material such as, without limitation, wood, plastic, or metal. Freestanding signs placed on hard surfaces in conformance with this Chapter are exempt from this Subsection provided they have a weight and mass that makes them difficult to inadvertently move and they do not block a 4-foot-wide pedestrian path of travel, do not have any motorized or other such mechanism to cause them to move or flutter, and are only displayed between one hour before and one hour after the site's establishment is open for business.

20.62.160 Illumination standards for signs.

The illumination of signs, from either an internal or external source, must be designed to avoid negative impacts on surrounding rights-of-way and properties. The following standards apply to all illuminated signs:

- A. Sign lighting shall not be of an intensity or brightness that will create a nuisance for residential uses in a direct line of sight to the sign. Light sources shall be shielded from all adjacent buildings and streets. The lighting shall not create excessive glare to pedestrians and/or motorists and will not obstruct traffic control or any other public informational signs. Illuminated signs located adjacent to any residential area shall be controlled by a rheostat or other acceptable method to reduce glare.
1. Illumination of signs shall be limited to a maximum illumination of 465 lumen per square foot (or 5,000 nits) during daylight hours and a maximum illumination of 47 lumen per square foot (or 500 nits) between dusk to dawn as measured from the sign's face. It is strongly recommended that automatic dimmers be installed in the sign.
 2. Signs in residential zones may only be indirectly illuminated by a concealed light source, shall not remain illuminated between the hours of 11:00 p.m. and 6:00 a.m., and shall not flash, blink, or fluctuate. Illuminated signs in residential zones must also be located on an Arterial or collector street.
- B. Internally illuminated signs shall be designed with an opaque, semi-opaque, or matte finish background on the sign face. Internally illuminated signs shall only be located on arterial or collector streets. Internally illuminated signs must not be located within 100 feet of a residential zone.
- C. Light sources for externally illuminated signs shall meet the following standards:
1. Low-pressure sodium lighting is the preferred light source to minimize undesirable light into the night sky.
 2. High-pressure sodium, metal halide, fluorescent, quartz, LED, and incandescent light sources shall be fully shielded.

3. Metal halide and fluorescent light sources shall be filtered. Most glass, acrylic, or translucent enclosures satisfy these filter requirements.
 4. Mercury vapor light sources shall be prohibited.
- D. External conduits, boxes, and other connections related to the function of a sign and associated lighting shall not be exposed nor pass through public right of way.

20.62.170 Sign regulations on undeveloped or developing sites.

- A. Undeveloped sites shall be allowed a maximum of two temporary freestanding signs with a maximum size of 32 square feet each. The maximum height shall be 10 feet. Signs shall be set back at least 10 feet from all property lines and the public right-of-way. Illumination of the sign is prohibited.
- B. Developing sites, i.e., construction sites, shall be allowed a maximum of two temporary freestanding signs or temporary building signs with a maximum size of 32 square feet each. The maximum height shall be 10 feet. Signs shall be set back at least 10 feet from all property lines and the public right-of-way. Illumination is prohibited. Temporary signs that are not visible from any public right-of-way shall not be counted in the maximum number or size of signs.
- C. In addition to any sign permitted pursuant to Subsection B above, residential subdivision sites where 10 or more new residences are offered for sale shall be allowed one temporary building sign or freestanding sign of a maximum size of 32 square feet. Illumination of the sign is prohibited. The maximum height shall be 10 feet. Additional temporary signs, temporary freestanding signs, and flags may be maintained within the boundaries of a residential subdivision provided that they are not visible from outside the residential subdivision and do not create a safety hazard by obstructing the clear view of pedestrian and vehicular traffic.
- D. Construction locations (example: remodel of a building) Signs may be placed during a construction event pursuant to the conditions of a permit issued by the City on the lot. Construction events begin on the date of the local structural permit approval and end on the date the permit is final or expires.

20.62.180 Signs placed in windows.

- A. Signs affixed to windows shall not cover more than 20% of each window and shall be placed so that there is an unobstructed view of the interior of the premises.
- B. Signs in windows shall not be counted toward the maximum allowable temporary or permanent building sign size.

20.62.190 Signs in public rights-of-way.

Only a governmental agency with authority over public right-of-way may place signs in the public right-of-way, with the following specific exceptions:

- A. Building signs may be located in the Downtown Overlay Zone that project into the public right-of-way, provided that the width of the projecting sign is a maximum of four (4) feet and that the bottom of the sign is eight (8) feet above the sidewalk or finished grade below it. An encroachment permit or licensing agreement is required.

- B. Building signs located on or under awnings in the Downtown Overlay Zone that meet the provisions of this Chapter.
- C. Temporary freestanding signs placed on the public sidewalk in the Downtown Overlay Zone that meet the provisions of this Chapter and when a minimum 4-foot-wide clear path of travel is provided.
- D. Government agencies, public institutions, and non-profit organizations may place banners on existing light poles in the public right of way, subject to a minor use permit issued by the Development Services Director and, if deemed necessary, an encroachment permit/license agreement issued by the City Engineer.

20.62.200 Comprehensive master sign programs.

- A. The purpose of the comprehensive master sign program provisions is to provide a coordinated and flexible design approach to signage for Merced’s commercial shopping districts, industrial districts, and office parks. A master sign program is required for any site that contains more than three (3) commercial establishments in a shopping center, industrial park, or office park.
- B. The comprehensive master sign program shall consist of all permanent building signs and permanent freestanding signs on the premises that can be viewed from a public street. The comprehensive master sign program shall establish a comprehensive design theme and set forth size, location, illumination, materials, and other design requirements for all signs.
- C. A comprehensive master sign program may be approved by the Development Services Director as a minor use permit. The Planning Commission may approve a master sign program when it is proposed with a development project that requires a conditional use permit if the information is available at the time of conditional use permit issuance. Otherwise, the Director may approve with a minor use permit.
- D. A comprehensive master sign program shall not be used to grant a special privilege nor provide more visibility or exposure than is available to similarly situated properties.
- E. Comprehensive master sign programs shall feature a unified and coordinated approach to the materials, color, size, type, placement, and general design of signs proposed for a project or property.
- F. Reasonable conditions of approval may be imposed to achieve the purposes of this Section and ensure internal sign design consistency on the site.
- G. After approval of a comprehensive master sign program, no sign shall be erected, placed, painted, or maintained, except in conformance with such program, and such program shall be enforced in the same way as any provision in this section.
- H. The master sign program and all conditions of approval applicable to a site shall be included with lease agreements for all leasable space subject to the comprehensive master sign program.
- I. Approval of a comprehensive master sign program does not waive the permit requirements for individual signs that are subject to the program.
- J. The Development Services Director may approve amendments to a comprehensive master sign program or at the Director’s discretion, may be referred to the original approving body.

- K. Proposed amendments to a comprehensive master sign program shall include written concurrence by the affected property owners.

20.62.210 Offsite temporary signs for residential subdivisions.

- A. Residential subdivision sites where 10 or more new residences are offered for sale shall be allowed up to four (4) offsite temporary freestanding signs with a size not to exceed 32 square feet each and a height not to exceed 10 feet. Signs shall be located on private, non-residential zoned parcels, or on private, residential zoned parcels that are part of a residential subdivision under construction, vacant, and otherwise free from any structures or buildings. Banners and flags with or without an advertising message shall not be permitted offsite.
- B. In addition to any sign permitted pursuant to Subsection A above, up to four (4) nonilluminated offsite temporary freestanding signs in an A-frame configuration, with a size not to exceed 12 square feet per face or four (4) feet in height, may be permitted per residential subdivision. A-frame signs shall be located on private, non-residential property or on public property behind any existing sidewalks, and in such a manner so as not to create a safety hazard by obstructing the clear view of, or otherwise hinder or impede, pedestrian and vehicular traffic. A-frame signs may only be displayed during operating hours for the residential subdivision sales office and shall be located no further than 1,500 feet from the subject residential subdivision entry.

20.62.220 Historic signs.

- A. Notwithstanding any other provision of this chapter, a sign which has been designated an historic resource in accordance with Chapter 17.54 or the reproduction of such a sign shall not be subject to the requirements of this Chapter, other than the requirement to obtain applicable building permits.
- B. Notwithstanding any other provision hereof, a structure that has been designated an historic resource in accordance with Chapter 17.54 or a structure over two (2) stories within the downtown area are eligible to adopt a comprehensive master sign program that meets the requirements of Section 20.62.200, and which may grant exceptions to the provisions of this Chapter.
- C. The Planning Commission may allow or require specific refurbishment or alteration of the sign designated as a historic resource. The applicant shall provide illustrations to satisfactorily describe how the sign will look after refurbishment.
- D. The Planning Commission may approve a change to the signed copy of a sign designated as a historic resource if it finds that the sign will retain its general historic appearance.

20.62.230 Signs with manual changeable copy.

- A. Manual changeable copy is allowed on signs in residential zones or in conjunction with residential uses in non-residential zones with a minor use permit. (Examples of uses that may need such signs are public assembly, schools, multi-family, etc.)
- B. Manual changeable copy shall represent no more than 20% of the total allowable sign area on commercial signs in commercial or industrial zones.
- C. This Section shall not apply to signs that indicate the price of motor vehicle fuel in conformance with the State Business and Professions Code that otherwise are in conformance with the other sections of this Title. Motor vehicle fuel price signs in conformance with State

Law shall be allowed and are exempt from size, height, and other requirements in this Ordinance that might interfere with them meeting the requirements of State law as regards to visibility, the prices being posted for all fuel types, the prices being visible from the public rights-of-way.

20.62.240 Signs with electronic changeable copy.

- A. Electronic changeable copy may be allowed on signs in residential zones or in conjunction with residential uses in non-residential zones with a minor use permit. (Examples of uses that may need such signs are public assembly, schools, multi-family, etc.)
- B. Electronic changeable copy is allowed as a display medium on freestanding signs in the commercial and industrial zone districts with a Minor Use Permit if the sign face changes less than once per minute. This includes signs that indicate the price of motor vehicle fuel in conformance with the State Business and Professions Code that otherwise are in conformance with the other sections of this Title.
- C. Electronic changeable copy is allowed as a display medium on freestanding signs with a Conditional Use Permit issued pursuant to this Title where the electronic copy changes more than once per minute.
- D. Signs with electronic changeable copy shall meet the following standards:
 - 1. The electronic sign face shall be directed in a manner that is not visible from the front or side of residential properties located in a residential zone district.
 - 2. The electronic sign face shall be an integral part of the remainder of the sign area.
 - 3. Electronic copy shall be limited to a maximum illumination of 465 lumen per square foot (or 5,000 nits) during daylight hours and a maximum illumination of 47 lumen per square foot (or 500 nits) between dusk to dawn as measured from the sign's face. It is strongly recommended that automatic dimmers be installed in the sign.
 - 4. No portion of the electronic changeable copy shall change more frequently than once per minute with a Minor Use Permit. The maximum electronic changeable copy allowed is once every eight (8) seconds with a Minor Use Permit. Scrolling, flashing, or other moving messages are not allowed.
 - 5. The electronic sign shall not emit any audible sound, buzz, or noise.
 - 6. Sign copy or electronic picture displays shall be limited to advertising related to the use(s) on the premises on which the freestanding sign is located, except for message substitution, as allowed in Section 20.62.030.
 - 7. No change of lighting intensity may occur during a display or between displays except to respond to a change in ambient lighting conditions.

20.62.250 Digital display signs.

- A. Digital display signs are allowed on freestanding signs with a Conditional Use Permit issued pursuant to this Title only within the Thoroughfare Commercial Zone, Regional/Central Commercial zone, General Commercial zone, Neighborhood Commercial zone, Commercial Shopping Center zone, Freeway Overlay District, Old 99 Overlay District, and any Planned

Development zone that has the equivalent General Plan Land Use Designation per Table 20.06-1 (“Base Zoning Districts”) to the previously mentioned zones.

B. Digital display signs shall meet the following standards:

1. The digital display sign face shall be directed in a manner that is not visible from the front or side of residential properties located in a residential zone district.
2. The digital display sign face shall be an integral part of the remainder of the sign area and shall be framed with a sign structure border that is a minimum of three (3) inches wide around the edge of the digital display area.
3. The digital display sign shall be limited to a maximum illumination of 465 lumen per square foot (or 5,000 nits) during daylight hours and a maximum illumination of 47 lumen per square foot (or 500 nits) between dusk to dawn as measured from the sign’s face. It is strongly recommended that automatic dimmers be installed in the sign.
4. No portion of the digital display sign face shall change more frequently than once every eight (8) seconds. No portion of the digital display sign face shall flash, blink, or include a video display.
5. The electronic sign shall not emit any audible sound, buzz, or noise.
6. Sign copy shall be limited to advertising related to the use(s) on the premises on which the freestanding sign is located, except for message substitution, as allowed in Section 20.62.030.
7. No change of lighting intensity may occur during a display or between displays except to respond to a change in ambient lighting conditions.

20.62.260 Flags and flagpoles.

- A. Flags that do not include commercial advertising on flagpoles shall not count toward the maximum sign area.
- B. Flagpoles shall not be located within any required interior side or rear building setback areas. Flagpoles may be mounted on the ground or on the roof or wall of a building.
- C. The maximum height of a flagpole shall be as follows:
 1. Flagpoles located in residential zone districts shall have a maximum height of 35 feet.
 2. Flagpoles located in non-residential zones shall have a maximum height of 50 feet if mounted on the ground, or 20 feet plus the height of the building if mounted on a building. The maximum height may be increased to 100 feet if the flagpole is located at least 200 feet from any property line or public right-of-way.

20.62.270 Search lights and klieg lights.

Search lights and klieg lights are prohibited, except when used for public safety purposes or when specifically approved with a temporary use permit for a special event.

20.62.280 Wall murals.

The City Council, Planning Commission, or Arts and Culture Advisory Commission may authorize a wall mural. When authorized, a mural would not be considered a sign for the purposes of this Chapter. A wall mural is to be public art, not for the purpose of identifying, advertising, or

drawing attention to a particular business, service, or economic activity. In the case that a mural is specifically identifying, advertising, or drawing attention to a particular business, the mural would need to be counted toward the allowable signage area for the business or activity and shall be subject to a sign permit. Less than 10% of the size of the mural may be used to identify the sponsor of the mural.

20.62.290 Off-premises signs in City right-of-way.

Notwithstanding any other provisions of this Title, the City Council may approve, through a special right-of-way leasing agreement, the erection of an off-premises sign within the City right-of-way. It must be deemed under the City Council to provide community benefit as defined and be under all the following circumstances:

- A. The sign shall be for a land use that addresses specific community benefits or priorities (i.e., the provision of groceries in a USDA-defined “food desert,” affordable housing, the provision of needed services within an income-qualified Census Tract, etc.).
- B. The size, location, height, and other design standards for the sign shall be determined on a case-by-case basis through the licensing agreement.
- C. The sign may incorporate a "changeable copy sign" of no more than 50 percent of the total actual sign area unless otherwise approved by the City Council.
- D. The owner of the land use that provides the community benefits shall erect the sign and maintain it at their sole expense.
- E. The owner shall agree to allow the City to advertise City or community/City sponsored events or emergency messages (traffic advisories, amber alerts, etc.), at the discretion of the City, on the sign on a continuous and ongoing basis as part of a continuous rotation of advertising or as otherwise defined by the City Council.
- F. Other than those City events above and the land use above that provides community benefits, the changeable copy sign shall not advertise any business, commodity, service, industry, or other activity which is not sold, offered, or conducted on the premises upon which the sign is located or affixed.

20.62.300 Nonconforming signs.

A sign of any character lawfully occupying a site prior to the adoption of this Chapter or on the effective date of applicable amendments to this Chapter that, as a result of the adoption or amendment to, does not conform with the standards for the district in which it is located, shall be deemed to be a nonconforming sign, and may be displayed and maintained in said district. Modifications to non-conforming signs may be allowed through a minor use permit.

20.62.310 Billboards.

- A. No new billboard shall be permitted within the city after the adoption of this Chapter, except as provided in this Section.
- B. Billboards existing in industrial zones on and prior to the adoption of this Chapter may continue to exist at their current location, subject to the provisions of this Chapter, and may be maintained or replaced from time to time, provided, however, that the total display area of any existing billboard shall not be enlarged in size or increased in height in any way.

- C. Billboards existing in any zone other than an industrial zone on and prior to the adoption of this Chapter are considered a nonconforming sign.
- D. No part of a billboard shall include a digital display sign, manual changeable copy, or electronic changeable copy.

20.62.320 Maintenance of signs.

- A. All signs and associated supporting structures shall be maintained in like-new condition, without rips, tears, fading, and similar damage that inevitably occurs as a result of normal wear and aging.
- B. All signs shall be reasonably free from deterioration, rot, rust, and loosening so that they do not create a hazard to persons or property or constitute a nuisance.
- C. Any sign or sign structure that is sagging, leaning, fallen, decayed, broken, deteriorated, ripped, torn, faded, or other deteriorating or dilapidated condition shall be promptly repaired to the satisfaction of the City or removed in accordance with City ordinance code 8.36.080.
- D. Graffiti on a sign shall be removed by the property owner (or designee) within two (2) days of notice of its placement on such sign. If graffiti is not removed, it will be subject to City Ordinance 8.36.070.

20.62.330 Hazardous signs.

Whenever any sign, by virtue of its physical nature and condition, is deemed by the Development Services Director, Chief Building Official, or Public Works Director to be an immediate and serious threat to public safety, City personnel may remove the sign or repair the physical deficiency to the extent necessary to protect the public safety. The cost of such removal or repair shall be assessed against the sign owner.

20.62.340 Abandoned or obsolete signs.

An on-premises sign advertising an activity, business, service, or product must be removed within 90 days following the actual discontinuance of the activity, business, service, or product. If the sign is not so removed, the Development Services Director may have the sign removed in accordance with the public nuisance abatement provisions of this Title. A sign structure is not required to be removed, however, the sign face shall be removed or replaced with a blank face or other sign face consistent with this Chapter.

20.62.350 Illegal Signs.

Any sign, banner, or sign structure not erected, constructed, or located in conformance with this Chapter and not classified as a legal nonconforming sign is an illegal sign and is subject to abatement in accordance with the public nuisance abatement procedures of Section 8.40.080.

20.62.360 Enforcement.

Signs erected after the effective date of this Chapter that either do not conform to the provisions of this Chapter or are erected without obtaining a required permit are declared to be unlawful and a public nuisance. All signs declared to be unlawful by this Chapter and all persons erecting or maintaining them shall be subject to the provisions of Merced Municipal Code Section 1.09.020

(Code Enforcement Authority and Powers). The remedies provided for in this Section are cumulative and nonexclusive.

20.62.370 Definitions.

The following terms are defined for this Chapter. Illustrations of rules for sign measurement are shown in Figure 20.62.090-1. The accompanying images and Figure 20.62.360-1 are intended to illustrate some of the sign types that are defined in this Section. If an interpretation discrepancy exists between the illustrations and the text of this Section, the text shall prevail.

"A-Frame sign" means a sign made of wood, plastic, or other lightweight and rigid material having the capability to stand on its own support(s) and being portable and movable.



"Animated sign" means a sign with action or motion, whether by flashing lights, color changes, wind, rotation, movement of any parts of the sign or letters or parts of the sign structure, or other motion.

"Arcade sign" means a sign suspended from the ceiling of a covered pedestrian walkway, which is attached to the building and oriented perpendicular to the building face to which the covered walkway is attached.

"Awning sign" means a sign placed on a shelter supported entirely from the exterior wall of a building and composed of a frame covered with nonrigid material.

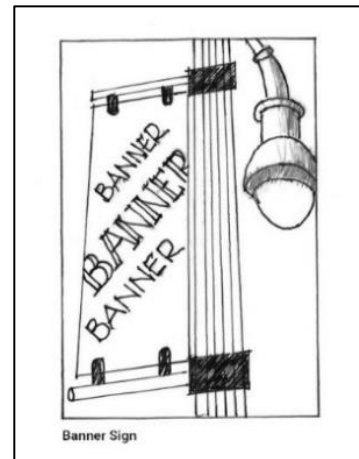

"Banner" means any flexible material, such as cloth, plastic, vinyl, paper, cardboard, or thin metal, with or without a "message", attached outdoors to a building, structure, or mounting device, or attached indoors to a building, structure, or mounting device so as to be visible from the exterior of a building, or structure. This definition includes a pennant, scroll, or bunting.

"Barber pole" means a pole with diagonal stripes of red and white or of red, white, and blue used as a sign for a barbershop that may or may not rotate.

"Billboard" means a sign which directs attention to a business, community service, or entertainment not exclusively related to the premises where such sign is located.

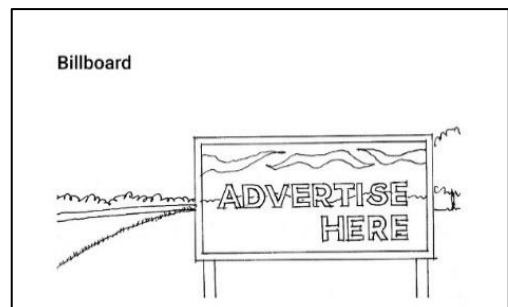

"Blade sign" means a pedestrian-oriented, non-internally illuminated double-faced sign, comprised of one (1) individual panel, projecting from the building wall on which it is mounted.

"Business premises" means a specific business occupancy within a building or upon a parcel of land, typically having a specific address and discrete entrance(s) and exit(s).

"**Can or cabinet sign**" means a sign that contains all the text and/or logo symbols within a single enclosed box-shaped cabinet where the translucent face of the sign can be interchanged to change the sign message without having to remodel the cabinet. It is mounted to a wall or other surface and illuminated from within the cabinet.

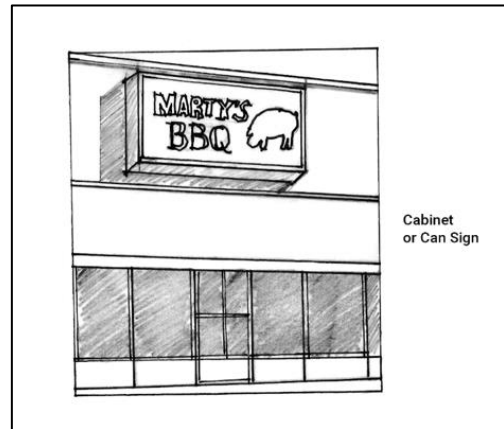

"**Changeable copy, electronic**" or "**electronic changeable copy sign**" means the display of a message that can change by means of electronic lights, light emitting diodes, video screens, or other illuminated electronic or electric format.

"**Changeable copy, manual**" or "**manual changeable copy sign**" means the display of a message that can change by manually arranging and attaching individual letters, numbers, or symbols.

"**Electronic digital display sign**" means a sign that displays images with or without a message through the use of grid lights, cathode ray projections, light emitting diode displays, plasma screens, liquid crystal displays, fiber optics, or other similar electronic media that may be changed remotely through electronic means.

"**Erect**" means and includes erect, construct, place, relocate, enlarge, substantially alter, attach, suspend, paint, post, maintain, and display.

"**Externally illuminated sign**" means a sign which has light cast on its surface from an artificial exterior source installed for the purpose of illuminating the sign.

"**Flag**" means a flat piece of cloth, with distinctive colors, patterns or symbols used to represent a country or group, having one end of the cloth attached to a vertical staff (directly or by a rope and pulley mechanism) and all other ends freely flowing under natural movement of wind.

"**Freestanding sign**" means a sign which is permanently supported on the ground by one or more uprights, braces, poles, or other similar structural components that are not attached to any building. This category includes both monument and pole signs.

"**Frontage, building**" means the distance between the two most distant corners of a building measured in a straight line along the building face.

"**Frontage, street**" means the distance between the two most distant corners of a site along a single street measured in a line along the street curb, including drive approaches, but excluding curb returns at street intersections.

"**Height**" means the distance measured vertically from grade to the highest point or portion of the object to be measured.

"**Internally illuminated sign**" means any sign whose illumination originates from within the structure of the sign and the source of which is not visible from the exterior of the sign.

"**Install**" or "**installation**" means the act by which a sign is constructed or placed on land or a structure, or the act of attaching, painting, printing, producing, or reproducing, or using any other method or process by which a visual message is presented or placed upon a surface.

"**Message**" means any form of visual communication presented on any type of media. It is not material whether the communication has any logical, practical, literary, or artistic significance or not. It includes any form or combination of letters, graphics, symbols, or designs. The term is not intended to include mono-color paint applied to the exterior, trim, fascia, or other architectural elements of a building for protection against the elements.

"**Monument sign**" means a low-profile freestanding sign supported by a structural base or other solid structural features other than support poles and may contain signage on more than one side (see drawing below).

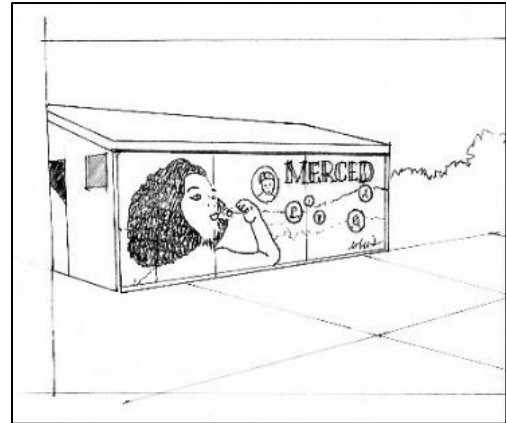

"**Mural**" means a sign painted on the exterior wall of a building consisting of graphics or images, either alone or in combination with letters.

"**Off-site**", "**off-site sign**", or "**off-premises sign**" refers to a sign or banner that promotes or advertises goods, services, or activities located or offered on a business premises or parcel that is separate from the parcel where the sign is located, even if the two sites or parcels are contiguous to each other.

"**On-site**", "**on-site sign**", or "**on-premises sign**" refers to a sign or banner that promotes or advertises goods, services, or activity located or offered on the business premises or parcel of property where the sign is located.

"**Outdoors**" means a location on undeveloped property or to the exterior of a building or structure.

"**Outdoor advertising**" refers to the placement of a message on signs or banners located outdoors or located indoors in a manner such that the message is visible from the exterior of a building or structure.

"**Outdoor advertising structure**" means a structure erected or maintained for the main purpose of displaying commercial outdoor advertising and located on a site other than the site on which the advertised commercial use is located or on which the advertised commercial product is produced.

"**Painted Sign**" refers to a sign that comprises only paint applied on a building or structure.

"**Parapet wall**" means an exterior wall that extends vertically above the roofline.

"**Parcels**" or "**property**" or similar references or descriptions shall refer to parcels defined or delineated by assessor parcel numbers maintained by the County tax assessor or as defined in the Glossary of this Code.

"**Pedestrian access**" means a doorway that has been designed for the primary use of the patrons or customers of that particular use.

"**Permanent sign**" means a sign that is solidly attached to a building, structure, or the ground by means of mounting brackets, bolts, welds, or other combination of attachment methods, thereby rendering the sign non-moveable or difficult to reposition without the use of machinery, cutting devices, or mechanical devices. See also "temporary sign."

"**Placed**" includes constructing, erecting, posting, painting, printing, tacking, nailing, gluing, sticking, carving, or otherwise fastening, affixing, or making visible in any manner whatsoever.

"**Pole sign**" means a permanently mounted, freestanding sign which is supported above the ground by one or more uprights, braces, poles, or other similar structural components.

"**Roofline**" means the highest point of a parapet wall or the main roof structure or the highest point of a parapet wall other than such architectural features as cupolas, pylons, projections, or raised portions of the roof.

"**Rooftop or roof-mounted sign**" means a sign that extends above the ridgeline of the roof of a building, or a sign attached to any portion of the roof of a building. Rooftop or roof-mounted signs are not allowed.

"**Sign**" means any letter or symbol made of cloth, metal, paint, paper, wood, or other material of any kind whatsoever placed for advertising, identification, written expression, or other similar purposes on the ground or on any wall, post, fence, building, structure, vehicle, or on any place whatsoever.

"**Sign area**" means the geometric area of a sign including all elements such as board or frames, perforated or a solid background, ornamental embellishments, arrows, or other sign media. For the purposes of a freestanding sign the structural elements necessary to support the sign are included in the sign area.

"**Sign copy**" means any words, letters, numbers, figures, designs, or other symbolic representations incorporated into a sign face and/or its structure with the purpose of attracting attention to the subject matter.

"**Sign face**" means the panel surface of a sign which carries the advertising, information, or identification message.

"**Sign structure**" means any structure that supports or is capable of supporting a sign. A sign structure may or may not be an integral part of a building. For the purpose of a freestanding sign, the sign structure shall include the aggregate area of the sign including the sign copy and all structural elements of the sign.

"**Structural alteration**" means any change to the sign structure.

"**Temporary sign**" means a sign that is easily moveable, and which is not attached to a building, structure, or the ground in such a manner as to be rendered a permanent sign.

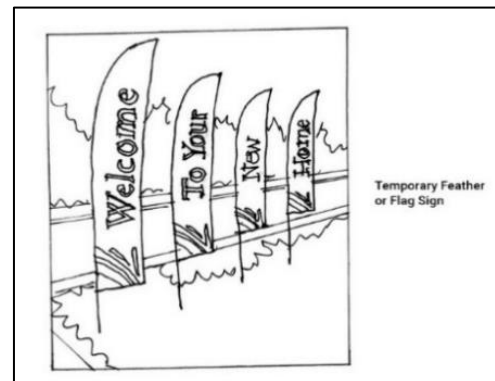
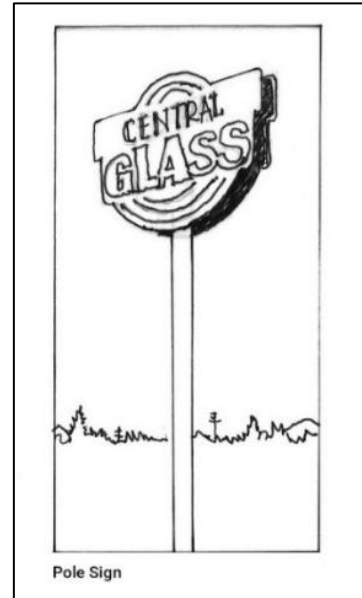

**Table 20.62.370-1
Illustration of Sign Types**

Different Types of Signs

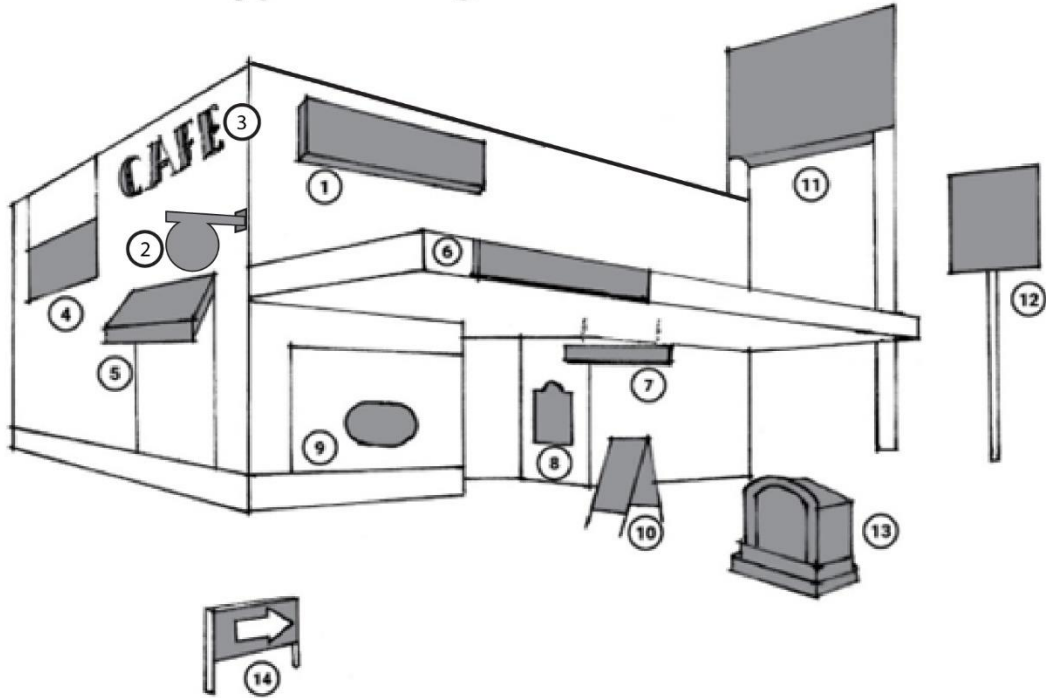

1. Permanent Building Sign (can or cabinet sign)	2. Permanent Building Sign (blade/projecting sign)	3. Permanent Building Sign (channel letter sign)	4. Temporary Building Sign (banner)
5. Permanent Building Sign (awning sign)	6. Permanent Building Sign (canopy-mounted sign)	7. Permanent Building Sign (arcade or hanging sign)	8. Permanent Building Sign (directory sign)
9. Temporary Building Sign (window sign)	10. Temporary Freestanding Sign (A-frame sign)	11. Permanent Freestanding Sign (pylon sign)	12. Permanent Freestanding Sign (pole sign)
13. Permanent Freestanding Signs (monument sign)	14. Permanent Building Sign (directional sign)		

CITY OF MERCED
Planning Commission

Resolution #4117

WHEREAS, the Merced City Planning Commission at its regular meeting of September 6, 2023, confirmed the denial of **Conditional Use Permit #1272**, initiated by Paramjeet Singh, on behalf of Encina Investment Group Mainplace Merced, LLC, property owner. This application involves a request for alcohol sales (beer, wine, and liquor) for off-site consumption for a new convenience market at 429 W. Main Street, generally located on the north side of Main Street, approximately 75 feet east of Canal Street, with a General Plan designation of Regional/Community Commercial (RC), within a Zoning classification of Central Commercial (C-C). The subject site is more particularly described as a portion of Lots 11, 12, 13, 14, and 15 from Block 162 on Recorded Map entitled “Supplemental Map to Town of Merced,” recorded in Volume 2, Page 12, in Merced County Records; also known as a portion of Assessor’s Parcel Number (APN) 031-143-028; and,

WHEREAS, the Merced City Planning Commission held a public hearing regarding this matter on July 5, 2023. At this meeting, the Commission voted to continue this matter to the Planning Commission meeting of August 9, 2023, to allow for additional information to be provided by staff; and,

WHEREAS, the Merced City Planning Commission opened the public hearing at the Planning Commission meeting of August 9, 2023, and heard additional information provided by staff. At that time, the Planning Commission adopted a motion of intent to deny Conditional Use Permit #1272 and directed staff to prepare Findings for Denial; and,

WHEREAS, the Merced City Planning Commission based its decision to deny Conditional Use Permit #1272 on the following Findings:

I-2. *The location, size, design, and operating characteristics of the proposed use will be compatible with the existing and future land uses in the vicinity of the subject property.*

As shown under Finding D – Building Elevation , Finding E – Floor Plan, and Finding F -Neighborhood Impact, staff believes that the location, size, design, and operating characteristics of the proposal would be compatible with existing and future land uses in the vicinity.

- I-3. *The proposed use will not be detrimental to the public health, safety, and welfare of the city.*

As shown under Finding H– Alcohol Sales, staff does not anticipate that this proposal would be detrimental to the public health, safety, and welfare of the City. Planning staff consulted with the Merced Police Department regarding alcohol sales at this location; the Police Department did not have any significant concerns with this request and is not requiring any conditions of approval not normally associated with alcohol sales for off-site consumption. Based on the information provided by the Police Department, staff does not anticipate that the approval of this request would adversely affect the public health, safety, and welfare of the City.

- K. The Planning Commission does not agree with Findings I-2 and I-3 as provided in the Draft Resolution at Attachment A of Planning Commission Staff Report #23-642.
- L. The Planning Commission finds that the proposed sale of alcoholic beverages for off-site consumption is not compatible with the businesses in the vicinity or the City’s vision for the downtown area. The sale of alcohol for off-site consumption may encourage drinking in public and other nuisances that would be detrimental to the other businesses in the vicinity. The City has worked hard to foster the downtown as an entertainment area for people of all ages and the Planning Commission finds that the sale of alcoholic beverages for off-site consumption would detract from this effort and cause harm to the other businesses in the area and the general public visiting the area.
- M. The Planning Commission finds that the proposed sale of alcoholic beverages for off-site consumption would create an atmosphere that would be detrimental to the public health, safety, and welfare of the City. The sale of alcoholic beverages for off-site consumption would encourage drinking in public, loitering in the area, create other nuisances that would create an unsafe atmosphere in the downtown area. The sale of alcoholic beverages for off-site consumption provides an option for patrons from the nearby bars to purchase alcoholic beverages and consume them on the street or sidewalk after they leave the bar or before entering another business in the area. This has the potential to increase calls for service from the police department and to make the public feel unsafe.

PLANNING COMMISSION RESOLUTION #4117

Page 3

September 6, 2023

NOW THEREFORE, after reviewing the City's Draft Environmental Determination, and discussing all the issues, the Merced City Planning Commission does resolve to hereby approve a Categorical Exemption regarding Environmental Review #23-18, and deny Conditional Use Permit #1272.

Upon motion by Commissioner Delgadillo, seconded by Commissioner Ochoa, and carried by the following vote:

AYES: Commissioners Smith, Camper, Ochoa, Thao, and Delgadillo

NOES: Commissioner Gonzalez

ABSENT: Chairperson Harris

ABSTAIN: None

PLANNING COMMISSION RESOLUTION #4117

Page 4

September 6, 2023

Adopted this 6th day of September 2023

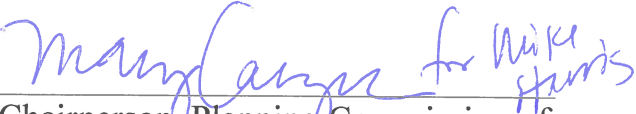
Chairperson, Planning Commission of
the City of Merced, California

ATTEST:

Secretary